COLORS FROM SPACE

A PROGRAM FROM THE HOLT PLANETARIUM



*by Michael Askins, John Erickson, Alan J. Friedman,
JohnMichael Seltzer and Alan D. Gould*

Jointly published by

*the Lawrence Hall of Science, University of California, Berkeley, California
and the New York Hall of Science, Flushing Meadows Corona Park, New York*

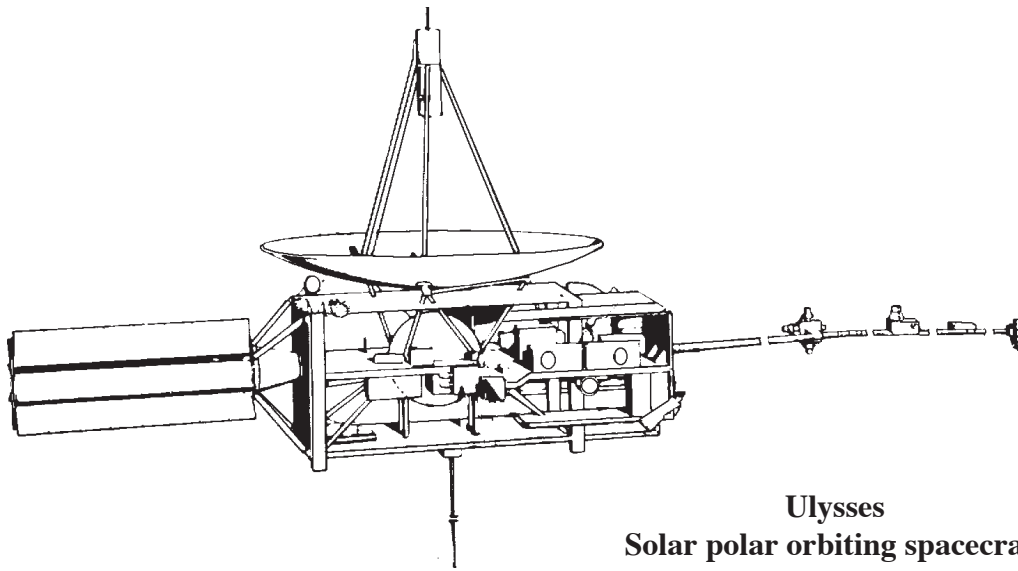

Ulysses
Solar polar orbiting spacecraft
NASA and European Space Agency joint mission
October, 1990 to September, 1995
(NASA drawing)

Cover photograph of the Ring Nebula in Lyra (M57) courtesy of Lick Observatory.

This material is based upon work supported by the National Science Foundation under Grant Number TPE-8751779. Any opinions, findings, and conclusions or recommendations expressed in this publication are those of the authors and do not necessarily reflect the views of the National Science Foundation.

Original Edition Copyright © 1990, by The Regents of the University of California.

First Revised Edition Copyright © 1993, by The Regents of the University of California.

This work may not be reproduced by mechanical or electronic means without written permission from the Lawrence Hall of Science, except for pages to be used in classroom activities and teacher workshops. For permission to copy portions of this material for other purposes, please write to: Planetarium Director, Lawrence Hall of Science, University of California, Berkeley, CA 94720.

The first printing of the *Planetarium Activities for Student Success* series is made possible by a grant from Learning Technologies, Inc., manufacturers of the Starlab Portable Planetarium.

**For latest information,
valuable links, and
resources relating to
the PASS series, visit:
[https://gss.lawrencehallofscience.org/
planetariums](https://gss.lawrencehallofscience.org/planetariums)**



Acknowledgements

The following staff members of the Lawrence Hall of Science Astronomy and Physics Education Project tested the first version of this program: Bryan Bashin, Cynthia Carilli, Cathy Dawson, Stephen Gee, Mark Gingrich, Cheryl Jaworowski, and Bob Sanders.

In 1988, grants from the National Science Foundation and Learning Technologies, Inc. have enabled us to publish *Colors and Space* as part of the *Planetarium Activities for Student Success (PASS)* series. Project Co-Directors were Cary Sneider, Director of Astronomy & Physics Education at the Lawrence Hall of Science in Berkeley, CA, and Alan Friedman, Director of the New York Hall of Science, in Corona, New York. Staff members of the Lawrence Hall of Science who contributed to the series included Lisa Dettloff, John Erickson, Alan Gould, John-Michael Seltzer, and Michelle Wolfson. Staff members of the New York Hall of Science who contributed to the series included Terry Boykie and Steven Tomecek. Special thanks are due to our Program Officers at the National Science Foundation, Florence Fasanelli and Wayne Sukow.

We wish to acknowledge the assistance provided by our Advisory Board, who helped to plan this series, and commented on early drafts: Gerald Mallon, Methacton School District Planetarium, Norristown, PA; Edna DeVore, Independence High

School, San Jose, CA; Philip Sadler, Project STAR, Harvard Smithsonian Astrophysical Observatory, Cambridge, MA; Sheldon Schafer, Lakeview Museum of Arts and Sciences Planetarium, Peoria, IL; Robert Riddle, Project Starwalk, Lakeview Museum of Arts and Sciences Planetarium, Peoria, IL; David Cudaback, Astronomy Department, University of California, Berkeley, CA; and Joseph Snider, Department of Physics, Oberlin College, Oberlin, OH.

Perhaps most important are the approximately 100 individuals from around the nation who attended leadership workshops in 1978, and an additional 200 educational leaders who attended three-week institutes in astronomy and space science at Lawrence Hall of Science during the summers of 1989, 1990, 1992, and 1993. These educational leaders provided valuable feedback for their final revision. Their names and addresses are listed in the Appendix to *PASS Volume 1, Planetarium Educator's Workshop Guide*.

In addition, we would like to thank the staff of the Astronomy and Space Science Summer Institutes: Joseph Snider, Terry Boykie, John Radzilowicz, John Hammer, Robert Jesberg, Jacqueline Hall, Dayle Brown, Alan Gould, Cary Sneider, Michelle Wolfson, John-Michael Seltzer, John Erickson, Lisa Dettloff, Kevin Cuff, Debra Sutter, Chris Harper, Kevin Charles Yum, John Hewitt, Gregory Steerman, Edna DeVore, and David Cudaback.

PASS Volume 8 Photos & Illustrations

p.ii, NASA, Ulysses spacecraft drawing; p.2, Alan Gould, White light drawing; p.3a, Alan Gould, Color lights module; p.3b, Alan Gould, Magic cloth; p.4, Alan Gould, Color analyzer; p.5 Alan Gould, Prism...; p.14a, NASA, Mars w/ red filter; p.14b, NASA, Mars w/ blue filter; p.14c, NASA, Color picture of Mars; p.14d, Lick Observatories, Jupiter w/ blue filter; p.15a, Lick Observatories, Jupiter w/ red filter; p.15b-d, Ring Nebula w/ red, yellow, green, blue filters; p.15e, Lick Observatories, Ring nebula in color; p.18a, Photo by Alan Gould, Putting on suntan oil; p.18b, Far Ultraviolet Spectroscopic Explorer Perkin-Elmer Space Science Division; p.18c, NASA, The sun in UV light; p.19a, Kaiser Permanente Hospital, X-ray; p.19b, NASA, HEO-2 Einstein Obser-

vatory; p.19c, NASA, The Sun in UV light; p.19d, Photo by Alan Gould, Heater; p.19e, NASA, IRAS; p.20a, NASA, Milky Way in IR; p.20b, Photo by Alan Gould, Microwave oven; p.20c, Photo by Alan Gould, Radio towers; p.20d, Radio telescope - National Radio Astronomy Observatory; p.20e, Radio image of Jupiter - National Radio Astronomy Observatory; p.21, Lick Observatories Observatory, Trifid Nebula; p.28, Alan Gould, Mixing Colors; p.29, Alan Gould, Color Wheel; p.31, Alan Gould, Spectroscopes; p.32, Alan Gould, Spectra; p.32, Alan Gould, Making a simple spectroscope; pp.36-43, John Erickson, Making & Using a Spectrometer; p.44, Lick Observatories, Eagle Nebula (M16).

Planetarium Activities for Student Success (PASS)

Series Editors: Cary Sneider, Alan Friedman, and Alan Gould

If you have access to a planetarium for teaching about astronomy, space science, and other subjects, this series of books is for you. Designed for both experienced planetarium professionals and teachers who will be using a planetarium for the first time, these volumes provide a wealth of field-tested strategies and practical suggestions for presenting entertaining and educationally effective programs for students.

The first four books provide a general orientation to astronomy and space science education with applications for both the planetarium and classroom settings. Each of the remaining volumes presents a complete planetarium program and related classroom activities. We hope you will find the materials useful in your work with students and teachers, as well as springboards for your imagination and creativity.

Volume 1: Planetarium Educator's Workshop Guide

Participatory planetarium programs involve students actively in the planetarium environment. The most effective programs are both entertaining **and** educational. This guide introduces the theory and practice of developing effective planetarium programs through a series of thought-provoking activities and discussions.

Volume 2: Planetarium Activities for Schools

This volume provides a wealth of effective planetarium activities for elementary and middle school students, as well as ideas for developing new activities for students of any age.

Volume 3: Resources for Teaching Astronomy & Space Science

There is a wide spectrum of resources for teaching astronomy and space science in elementary and middle schools. This annotated resource guide has the best resources that we have found, including school curricula, books, periodicals, films, videos, slides, professional organizations, planetariums, and telescopes.

Volume 4: A Manual for Using Portable Planetariums

Primarily a “how-to” manual for setting up and using a portable planetarium, this guide has many suggestions useful for teaching school programs in **any** planetarium.

Volume 5: Constellations Tonight

In this participatory version of a classic night sky planetarium program, students receive star maps and have an opportunity to use them to find constellations in the planetarium sky. Classroom activities include creating constellations and using star maps.

Volume 6: Red Planet Mars

Students discover Mars three different ways during this planetarium program. They find the red planet by observing it over a period of several nights as it moves against the background stars. Then they view it through a telescope and try to draw a map of its surface. Finally they see Mars via space probes. Classroom activities involve students in modeling the solar system, and creating creatures that might survive under different planetary conditions.

Volume 7: Moons of the Solar System

This program begins with observations of the Earth's Moon and a modeling activity that shows why the Moon goes through phases and eclipses. Then the students look at Jupiter's four major moons on a series of nights and figure out how long it takes each one to circle Jupiter. Finally, the students journey through the Solar System to see many moons through the "eyes" of modern spacecraft. Classroom activities involve students in performing experiments in crater formation, using moon maps, and designing lunar settlements.

Volume 8: Colors From Space

What can we learn about the stars and planets from their colors? Answering this question requires a fundamental understanding of why we see color. During this program, students deepen their understanding through a series of activities in which they "travel" to an imaginary planet circling a red sun, and experiment with color filters and diffraction gratings. Related classroom activities include making secret messages that can only be decoded with color filters, and then using the same filters to view nebulae and planets.

Volume 9: How Big Is the Universe?

Based partly on ideas from the short film *Powers of Ten*, this program surveys distances and sizes of things in the universe. Starting with ordinary things on Earth that students are familiar with, they move to progressively more distant astronomical objects: the Moon, the Sun, the Solar System, nearby stars, the Milky Way galaxy, and clusters of galaxies. Students use various methods to determine distance: parallax, "radar," and comparing brightness of objects. Classroom activities include students writing their complete galactic address, making a parallax distance finder, finding the distance to the "Moon," and activities about the expanding universe.

Volume 10: Who "Discovered" America?

Students ponder the meaning of the word *discover* in this program. Can one "discover" a land where people are already living? Students learn the reasons and methods by which Columbus navigated to the "New World," and some of the impacts of his voyages on Native Americans. They also find that certain myths about Columbus are untrue. He was not, for example, alone in believing that the Earth is round. Students also learn about other explorers who "discovered" America long before Columbus's time. Classroom activities include determining the shape and size of the Earth, using quadrants to determine latitude, and modeling lunar eclipses.

Volume 11: Astronomy of the Americas

There are hundreds of Native American cultures, each with distinctive views of the heavens. There are also common threads in many of those cultures. In this program students visit five cultures: the Hupa people of Northern California, plains and mountain tribes that have used Medicine Wheel in Northern Wyoming, the Anasazi of Chaco Canyon in New Mexico, the Mayan people in Mexico and Central America, and the Incan people in Peru. Students observe moon cycles and changes in the sunrise and sunset positions on the horizon and learn how solar observations help Native Americans stay in harmon with nature. Classroom activities include the Mayan and Aztec number systems, observing changes in real sunset positions, and learning how Venus can appear as either the "Morning Star" or "Evening Star."

Volume 12: Stonehenge

In this program, students learn what Stonehenge is and how it could have been used by its builders as a gigantic astronomical calendar. They also learn how astronomer Gerald Hawkins discovered Stonehenge's probable function, by actively formulating and testing their own hypotheses in the planetarium. Along the way, they learn a lot about apparent solar motion, and the creation of the research field of "archaeo-astronomy." Classroom activities include constructing a special Solar Motion Demonstrator to represent the entire yearly cycle of solar motion.

Colors From Space

Contents

PLANETARIUM PROGRAM

Preface	1
Objectives	1
Materials	2
Recommendations for Using the Script.....	6
Set Up	6
Script	7
Colors and Temperatures of Stars	7
What Color Are Your Blue Jeans?	9
The Magic Cloth	10
Filters	12
Diffraction Gratings	16
What Stars Are Made Of	17
Invisible Colors	18
The Secret Message (in UltraViolet Light) ...	21
Discover More About Colors From Space	23

CLASSROOM ACTIVITIES

Mixing Colors	26
Spectroscopes	31

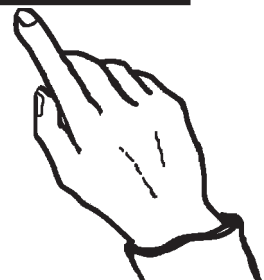

*Colors
from
Space*

*Planetarium
Program*

Preface

Colors From Space was designed for public audiences and for school children in grades three and above. Presentations for younger age children (grades 1-2) are possible with some simplification.

The program begins by students observing and pointing out stars of different colors. They then see a demonstration of how the color of a star is related to its temperature. The class pretends to go to a planet orbiting a red star and observes how the colors of objects appear different, depending upon what color of light is shining on them.

Next the students use light filters to how different color filters can allow astronomers to see particular details in astronomical objects. Then, they use diffraction gratings to analyze the colors that comprise light and determine what stars are made of by examining emission spectra. Finally, the students find out some of the ways that astronomers detect invisible colors of light that are beyond the ordinary visible rainbow colors of light.

Understanding color absorption and reflection is not common sense and takes time. We recommend that you prepare yourself as well as your students with background activities found in the Great Explorations in Math and Science (GEMS) guide, *Color Analyzers*, available from Discovery Corner, Lawrence Hall of Science, University of California, Berkeley, CA 94720.

As with all of our planetarium programs, we would be very grateful to hear from you about how you used this program, what modifications you made, what worked well and what didn't work well.

Objectives

In this planetarium program, the students will be able to:

1. Explain, in terms of reflection or absorption of light, why objects appear to be certain colors.
2. Explain what color light filters do to light.
3. Tell some ways in which astronomers use filters.
4. Describe how a diffraction grating or prism can be used to see the component colors in light.
5. Distinguish various elements by their emission spectra.
6. Explain how astronomers can tell what stars are made of by analyzing starlight with diffraction gratings.
7. Tell about how astronomers use special instruments to "see" invisible "colors" of light.

Materials

- 1. Battery-operated light pointers.** These are available from photographic stores. Have at least two light pointers (one bright and one dim) or a single light pointer with variable brightness. If you use a battery powered light pointer, it can be made dim by making one of the batteries a “dummy” battery (short circuit). Ready-made dummy batteries are available at electronic supply stores such as Radio Shack. (See PASS Volume 5, Constellations Tonight, for more information on light pointers.)
- 2. Unfrosted tubular white light bulb** (long filament preferred) with variable dimmer. To save space, this light can be mounted with the color lights described in item 3 on the following page.

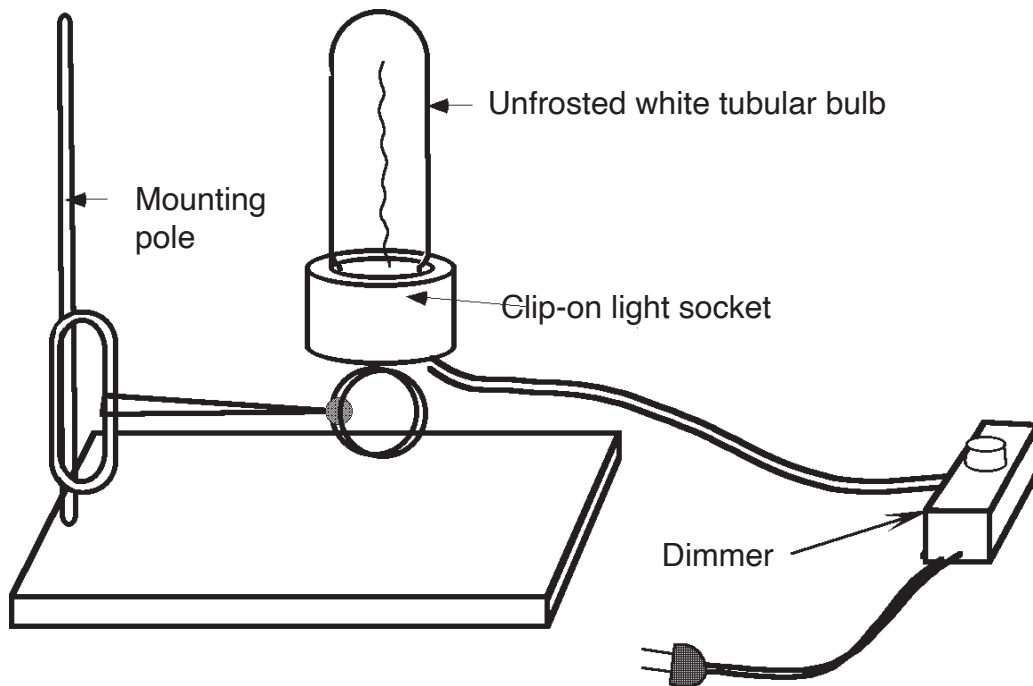

3. Color lights module. The simplest version to make consists of three colored flood lights (red, green and blue) in clamp-on light fixtures with metal reflectors. To get as pure color light as possible, secure color filter gels over the the reflectors with tape. If the filters are good enough, ordinary white flood bulbs may be used in the fixtures. Dichroic bulbs may also be used. The following types of filters have been found to be very good:

Medium Red (RoscoLux #27)

Kelly Green (#94)

Medium Blue (#88)

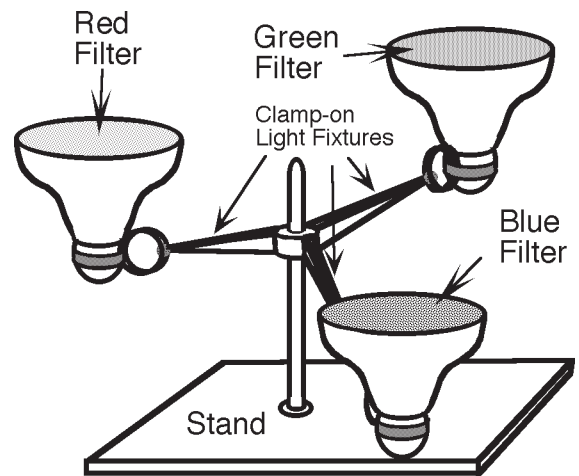

4. Special-pattern “magic” cloth. We use two lengths of cloth, each about 18" wide and and 24 feet long. The fabric has a pattern with colors shown below. When viewed with a red filter, the zig-zag stripes seem to disappear “magically” because they blend in with the color of the stripes they are on. The exact pattern of cloth is not important as long as some dramatic “disappearance” of a color in the fabric occurs with one of the color filters of the color analyzer. The red filter is the best one we have found for this purpose. To find the right fabric for your planetarium, take color filters to a fabric store and view various fabrics through the filters until one with a suitable dramatic effect is found. No color lights are necessary for these in-store tests, since the filter allowing only one color of light to reach your eye accomplishes the same thing as a pure color of light shining on the cloth. You may also find suitable patterns in gift wrapping papers or decorative paper plates.

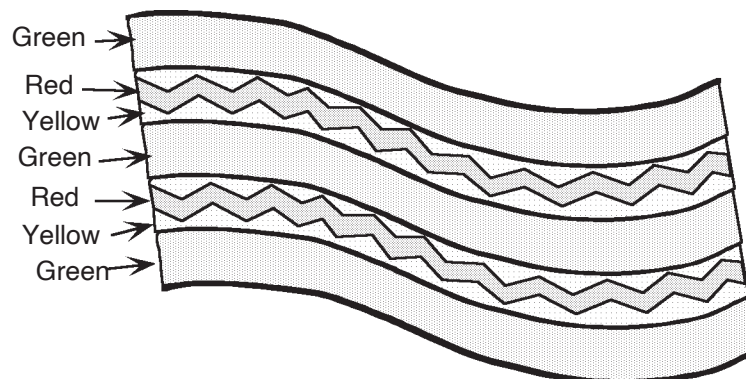

Colors From Space

5. **Color analyzers** (see diagram below). Make one for each student with a few spares for good measure. Our color analyzers each have two pieces of wood or opaque plastic (about 10 x 15 cm.) with four holes drilled in them. Color filters (red, green and blue) are secured in three of the holes and a diffraction grating is placed in the fourth hole. Two large clear acetate rectangles sandwich the diffraction grating and filters. The two pieces of wood or plastic are held together either with screws or high quality sticky tape. The holes are then labelled "A," "B," "C," and "D." A message (word) written with invisible fluorescent ink or a fluorescent sticker is affixed to it. Making the message with yellow highlighter pen on yellow paper works well.

Color Analyzer

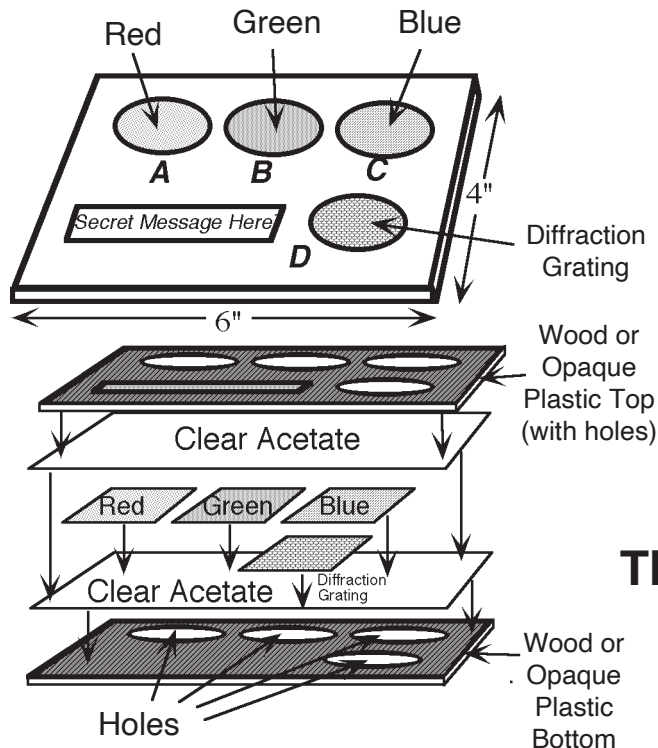

The Sandwich

For diffraction gratings, we recommend hologram replica diffraction gratings available from Learning Technologies, Inc., 59 Walden St., Cambridge, MA 02140; 800-537-8703; Flinn Scientific Co. P.O. Box 219, Batavia, IL 60510-0219, 312-879-6900; or Fluid Forms, Box 1107, Topanga, CA 90290.

6. **Spectrum tubes** including different gases, such as hydrogen, helium, neon, mercury. (Available science supply companies such as Frey Scientific in 905 Hickory Lane, Mansfield, OH 44905; 800-225-3739 or Science Kit & Boreal Laboratories, 777 E. Park Dr., Tonawanda, NY 14150-6784; 800-828-7777.)
7. **High voltage spectrum tube power supply** with a long extension cord. (Same sources as in item 6 above)
8. **Ultraviolet lights** (black lights) to flood the planetarium. Use only long wavelength bulbs; short wavelength UV light can cause eye damage.
9. **Images** for *Colors From Space* are listed on the following page. Complete slide sets may be purchased from Learning Technologies, Inc., 59 Walden St., Cambridge, MA 02140; 800-537-8703. If you have a video system with a laserdisc player and the Optical Data Corporation's "Astronomy Disc" a.k.a. "Earth Science Sides 3 & 4," many of the needed images can be programmed from that disc.

Image	Astronomy Laser Disc #	Slide Source
1. Viking Lander with red filter	12843**	LHS, NASA, Finley-Holiday, Mt. Wilson Obs.
2. Viking Lander with blue filter	12843**	LHS, NASA, Finley-Holiday, Mt. Wilson Obs.
3. Viking Lander in full color	12843**	NASA, Finley-Holiday, Mt. Wilson Obs.
4. Jupiter with blue filter**	8724	LHS, Lick Observatory
5. Jupiter with red filter**	8725	LHS, Lick Observatory
6. Ring nebula with filters**	1268-1271	LHS, Kitt Peak National Observatory
7. Ring nebula in color	1260	ASP, Hansen, ...
8. Suntan	474	LHS, Your own staff
9. Far UV Explorer Satellite	487	ASP ("Future Astronomy From Space")
10. Venus in UV	489	ASP, Hansen, Finley-Holiday
11. X-ray	475	LHS, your local hospital
12. HEO-s Einstein Observatory	490	MMI Corp. ("Visions of Einstein")
13. The Sun in X-rays	10434	MMI Corp. ("Visions of Einstein")
14. Electric Heater	472	LHS, your own heater
15. Infrared Astronomical Satellite ..	479	ASP ("Infrared Astronomy")
16. Milky Way in Infrared	481	ASP ("Infrared Astronomy")
17. Microwave oven	471	LHS, your own oven
18. Radio towers	470	LHS, make your own
19. Radio telescope	477	ASP ("The Radio Universe")
20. Radio image of Jupiter	478	ASP ("The Radio Universe")
21. Trifid Nebula (NGC6514; M20)	1030	ASP, Hansen, ...

* **ASP:** Astronomical Society of the Pacific, 390 Ashton Ave., San Francisco, CA 94112

LHS: Lawrence Hall of Science, University of California, Berkeley, CA 94720

Hansen: Hansen Planetarium, 15 South State St., Salt Lake City, UT 84111

Finley-Holiday: Finley-Holiday Film Corp., P.O. Box 619, Whittier, CA 90601

MMI Corp: P.O. Box 19907, Baltimore MD. 21211

Optical Data Corporation: (for videodiscs) 30 Technology Dr., Warren, NJ 07060

** This image can also be prepared by putting an appropriate color filter on a color slide

† Laserdisc image (487) is of the Orbiting UV Observatory; differs from slide 9.

Optional

10. **Bottle of tonic water**, to show fluorescence.

11. **Prism, slide projector and slide of a slit.** The bright beam of a slide projector passing through a slit and a stand-mounted prism produces a relatively large spectrum on the dome. This can be used as a supplement or alternative to the activity with the diffraction gratings. The prism itself can be made of glass, plastic or a water-filled glass container. Place the slit slide after image 12 (ring nebula in full color). To demonstrate the effect, during the program turn on the projector with the slit slide, and place the prism stand directly in the path of the light beam. The prism should be pre-positioned so that setting it in place produces a good sized beam and a fairly bright rainbow on the dome.

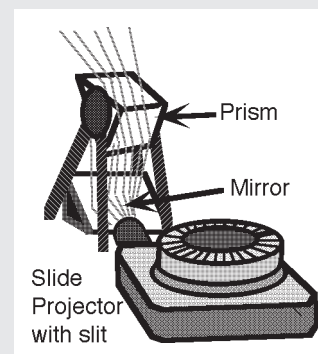

12. **Object with fluorescent paint** to display to the audience.

13. **Give-away diffraction gratings.**

Set Up

1. Set planetarium according to current skies and note the colored stars visible at the time. Turn on daylight for the opening of the program.
2. Put the unfrosted white bulb in the center; check that it is at a dim setting so that it will not blind people when it is turned on.
3. Point colored floodlights directly towards the top of the dome.
4. Hide special-patterned “magic” cloth out of sight.
5. Have all other equipment on hand within easy reach.
 - * Light pointer(s)
 - * Color Analyzers
 - * Spectrum tubes and Power supply
 - * Tonic water
6. Cue slide projector(s) to the first slides and the first image.
7. Optional:
 - * Set up stand with prism mount over projector with slit.
 - * Have fluorescent item ready.

Recommendations for Using the Script

We don't expect the script which follows to be memorized (as an actor might memorize a part) but to be used as a guide in learning, rehearsing, and improving presentations. We recommend that you read the script once or twice, then work with it in the planetarium, practicing the projector controls, slides, special effects, and music. You should be able to imagine yourself presenting information, asking questions, and responding to participants. For your first few presentations, you can have the script on hand, using major headings as reminders of what to do next.

The script is organized in blocks or sections. The purpose of these separations is only to help you learn and remember what comes next. Once you have begun a section, the slides or special effects and your own train of thought will keep you on track. When beginning a new section, make the transition logically and smoothly.

Directions for the instructor are printed in *italics*, the instructor's narrative is printed in regular type, and directions and questions to which the students are expected to respond are printed in ***bold italics***. There is no point in memorizing narration word-for-word since what you need to say will depend upon the students. The language you use and the number and kinds of questions you ask will depend on how old the students are, how willing they are to respond, and how easily they seem to understand what is going on.

We believe the most important elements of the program are the questions and the activities since these involve the students in active learning. If you must shorten your presentation, we recommend that you borrow time from the narration.

Script

Entrance music on while people come in. Then, fade out music .

Greetings! My name is _____ and I want to welcome you to today's planetarium program, "Colors in Space." This evening, when we look at the stars, we may want to consider them from a different perspective: how much can we learn about the stars from their constant twinkling lights?

All we have ever received from stars is their light, and it is up to us to discover their secrets and the nature of the universe by unravelling the information contained in that light.

One important feature of light is color. ***What color (or colors) would you say the stars are?*** (Accept any answers: white, yellow, grey, silver, clear, etc.)

Although most stars may look white or yellow to us, there are quite a few stars that glow with a different color; some red or reddish, some bluish, but it takes a certain level of brightness for the eye to recognize color. Next time you are outside on a starry night, look carefully and see how many differently colored stars you can find.

In the planetarium, we can speed up time. As the day wears on and the sun goes down, the sky will get darker and, if it's a clear night, the stars will come out.

Slowly fade out lights. Fade in stars, fade in music and wait to allow eyes to adjust and let people look at the stars; then fade out music.

Colors and Temperatures of Stars

Now, let's find some stars that have a different color than usual. ***Can you find any stars that have some unusual color, different from white, yellow, silver?*** If you would like to point it out to the rest of us, raise your hand so that I can give you a light pointer.

Demonstrate pointer. Have several volunteers point out stars of different colors. For each volunteer..

What color does that star seem to you?

Yes, there are stars of many different colors. ***Why do you think the stars shine with different colors?*** (Accept a few answers.)

Most of the stars we see are big balls of hot, glowing gas. But all fires are not the same temperature and similarly, not all stars are the same temperature. For that reason they are different colors.

Colors From Space

Which stars do you think are hotter: the yellow or the red stars? Raise your hand if you think the yellow stars are hotter. Raise your hand if you think the red stars are hotter. Let's do an experiment to find out: Here I have a regular white light bulb which gives off light from a hot metal wire. I can regulate its temperature.

Turn on white bulb in the center and vary brightness to demonstrate. Make sure that everyone can see the light bulb directly.

You may need to move a little so that you can see the wire inside the light bulb. Right now, it is the hottest I can make it. **What color is it?** (White.)

Start dimming slowly.

I'll cool it off a little. **What color is it now?** (Yellow.)...**and I cool it off more...** (Orange.) ...**and just when it's about to die out...** (Red, then black.)

Start making it brighter again slowly.

If we slowly make it hotter again, what colors does it get? (Red,...orange,...yellow,...white.)

Of all these colors, what color are the hottest stars? (White.)...**and the coolest?** (Red.) **Which stars are hotter than red but cooler than white?** (Orange and yellow.) There are stars that are even hotter than the white stars. If I could make the light bulb hotter it would turn bluish and then maybe even purpleish. **Have you ever seen a blue fire?** (On the gas stove, an oxy-acetylene torch.) Blue fires are very, very hot. **On the other hand, have you seen the dying cinders in a fireplace?** (They look very red.) Similarly with the stars, the blue stars are very hot and the red stars are the coolest, even though they're still very hot!

Optional: Red stars are usually less than 4,000° Celsius (7,000° F.), blue stars are usually above 10,000° Celsius (18,000° F.), and medium hot stars like our Sun are 5,000–6,000° Celsius (roughly 10,000° F.)—all surface temperatures. Temperatures in the centers of stars are millions of degrees!

Stars, like all fires, also cool off with time. **What will happen to the color of a blue star as it cools off?** (It will turn from blue to bluish-white, to white, to yellow, to orange, to red, and finally to black.)

What color is the closest star to us? (Yellow.) **What's the name of that star?** (The Sun.) The Sun is an average yellow star. **Do you think the Sun will always be yellow?** (No. It will cool off and become orange, then red.) Billions of years from now, our sun will become a red star and things might look very different on Earth. Let's take a look at what things might look like when that happens.

Turn on red light to flood the planetarium, all other lights out.

What Color Are Your Blue Jeans?

Look at your clothes. Notice what the colors look like now. If you are wearing red notice if it looks bright or dark. **Who is wearing something red?**

Ask a volunteer wearing something red to stand so everyone can see the red clothing.

Who is wearing something blue?

Ask a volunteer wearing something blue to stand so everyone can see the blue clothing.

I'll ask my volunteers to stand up to display their red and blue clothes so we can compare them. **Which one looks brighter?** (The red.) **What colors look bright under a red light?** (Red, white, and other light colors like yellow and pink.)

Now, let's transport ourselves to a place near a blue star. **Are blue stars hotter or cooler than red stars?** (Hotter.) Please fasten your seatbelt. We will be using "warp drive with warp factor 100" leaving the red star to go to a planet orbiting around a blue star!

Red lights off; blue flood lights on.

Here we are on a planet revolving around a blue star. What's different now? Notice the colors around you again. **Which colors look brighter?** (Blue and white.)

I'll ask my volunteers to stand again so we can compare their clothes under this new light. **Which one looks brighter?** (The blue.) It seems that blues and whites and perhaps greens look bright under a blue light; all other colors look dark.

Let's go back and forth between the red and the blue stars and watch what happens to our volunteers' clothes.

Alternate red and blue lights a few times and finish, leaving red lights on. Ask volunteers to be seated.

To understand the effects we just saw, we need to trace the path of light. All the light in this room is coming from this red bulb. **Where does the light go next?** (Upwards to the top of the dome.) When the light hits the top of the dome it bounces off in all directions. We call this bouncing-off *reflecting*. So, the light from the red bulb bounces off the dome and reflects all over, hitting other things and reflecting off of them. But when light hits things it doesn't always bounce off or *reflect*, sometimes it is *absorbed*. Just like a sponge can absorb water, things can absorb light. When an object reflects light, some of that reflected light comes into our eye and we see the object bright. When an object absorbs light, the light doesn't reach our eye and it looks dark. Look at the red clothing in this light. **Does red light reflect from it into our eyes or does the clothing absorb the red light?** (Reflects.)

For younger groups, start out with the phrase "bounces off" for "reflect" and "is trapped" or "soaks in" for "absorbed."

Colors From Space

Look at blue clothing. **Does the red light reflect from it into our eye or does the blue clothing absorb the red light?** (Absorbs.) Now, let's do the same experiment in blue light.

Turn off red; turn on blue.

Does the blue light reflect off of red objects or is it absorbed? (Absorbed.) **And does the blue light reflect off of blue objects or is it absorbed?** (Reflects.) This is why things appear to be colored; blue objects reflect mostly blue light and absorb most other colors, while red objects reflect mostly red light absorbing most other colors. Objects with colors like white and yellow reflect most colors of light.

Turn off blue; turn on red.

The Magic Cloth

Now, let's go back to a red star and examine a piece of cloth. Space travellers call it "the mystery cloth" because they have a hard time agreeing on the colors they see on it.

Make sure only red light is on. While you talk, start unrolling the multicolored cloth so that everyone will have a piece of it in front of them; once you start, let the audience continue unrolling it.

Will someone please describe the pattern on this cloth for us? (Stripes of the same width; colors.) **Does everyone agree with that description?** (Accept a few opinions.)

Perhaps we can agree that there is a bright stripe that *reflects* red light (or looks bright under red light) and a dark stripe that *absorbs* it (or looks dark under red light).

Let's take the cloth to a different star, a green star perhaps, to see if we can get some more information about the colors of this cloth. Please fasten your safety belts again.

Red lights off; on green lights. Expect gasps of astonishment from your students.

Wow! What happened!!? Could this be the same piece of cloth? **Would someone please describe this new pattern for us?** (There's a new thin zig-zag line, so there are three stripes of different widths. Colors?) **Does everyone agree with this new description?** (Listen again to a few opinions.)

We want to discover the true colors of each of those stripes, and to do this we can use what we learned when we looked at our clothes under different color lights. **Does that zig-zag look bright or dark?** (Dark.) That is because it must be absorbing the green light.

Is it possible that the zig-zag could be green? (No. If so, it would look bright.)

What about the background stripe that the zig-zag is on, does it look bright or dark? (Bright.) It looks bright because it is reflecting the green light.

Is it possible that the background could be green? (Yes.) Could it be another color? (White.) Now keep track of that zig-zag by putting your finger on it while we return to the red star to see what happens.

Turn green light off; red light on.

The zig-zag disappeared! Where did it go? I told you to keep track of it!! *Now, does the area where the zig-zag is supposed to be look bright or dark? (Bright.)* The zig-zag and its background are two different colors but they are reflecting red light equally. *Is it possible the zig-zag could be red? (Yes.)* ...and now its background looks bright, too; *could it be red, also? (No.)* It looks bright with both red & green, so it probably is white, yellow, or some other color that reflects both red and green. Now, put your finger on the dark stripe. *Could this be red? (No, because it absorbs red light.)* Let's go to a green star.

Red light off, green light on.

The stripe looks bright. *What color do you think it could be? (green; or maybe, blue.)* If it is blue it should look brighter near a blue star: let's see.

Green light off, blue light on.

It looks darker, therefore it's not blue, it's probably green. So far we have guessed a wide green stripe, and a red zig-zag on a white or yellow background. *What color light do you think we could shine on the cloth to see its real colors?*

If they say: red, blue, green, respond: "We already looked at it with those colors." When they say any other color: "I only have red, blue and green." When they suggest white or a combination...

Let's see what happens when we combine colors. Look at the ceiling as I mix the colors: We have blue light, now we add green.

Green light on.

We get aqua (or turquoise, cyan, or plain blue-green). Let's add red to blue.

Green light off. Red light on.

We get pink (or purple, or magenta). Let's add green to red.

Blue light off. Green light on.

We get yellow! *(This is usually a surprise for most people.)* And finally let's have red, green and blue together.

Blue light on.

Colors From Space

We get nearly WHITE!! White light is made from *all* colors mixed together. Look at your clothes now. ***Do they look their normal color again?*** (*Yes.*) Now we can see the “true” colors of the cloth and we find that we were correct in our guesses.

Please roll-up the cloth that is not-so-mysterious anymore.

Collect cloth once it is rolled up. Turn on red light only.

In summary, we can say that **an object looks brightest when illuminated by light of the same or nearly the same color (because the object reflects the light), and looks dark when illuminated by a light of very different color (because the object absorbs the light)**. Pale colors and white look bright in any color light, and dark colors like black, or brown, look dark in any color light. The red zig-zag and its pale background looked equally bright in the red light. In fact we could not tell they were different and that’s what made the zig-zag disappear. On the other hand, in blue or green light the red became very dark, while the pale background remained bright. This is because light striking an object is either reflected into our eyes, or absorbed. Objects **reflect** mostly the color light that they appear to be, and **absorb** all other colors.

Filters

We just looked at light **reflected** from objects like cloth. We will now look at how light goes **through** certain kinds of windows. I am handing out some devices that we call “color analyzers.” When you get yours look for four windows, each of them labelled with the letters **A**, **B**, **C**, and **D**.

Hand out the Color Analyzers, keeping one for yourself. Make sure only the red light is on.

I’d like you to hold your color analyzer up and look at the ceiling through the windows.

Demonstrate with yours.

Which window looks brightest? (D.) Which is second brightest? (*A.*) Notice windows **B** and **C** look black or very dark. Each window has a different color of plastic in it. Can you tell what color each window is? ***What color is window A? ...B? ...C?*** Let’s go to a different star, say a green star.

Switch off red, switch on green.

Now, which window looks brightest? (D.) And the second brightest? (*Window B, but window C is also bright.*) Also, notice that window **A** looks dark. ***Do you want to revise your guess as to what colors the windows are?*** Let’s go to a blue star.

Switch off green, turn blue on.

Again, which window looks brightest? (D.) And the second brightest? (Window C, and now window B is bright but dimmer.) Notice again that window A looks dark. Now, do you think you can guess what colors windows A, B, C and D are?

Turn off blue; turn on red.

What color do you think window A is? (Red.) And window B?

Turn off red; turn on green.

(Green.) And window C?

Turn off green; turn on blue.

(Blue.) And window D?

Turn on red, green and blue.

(Clear, transparent.) The plastic in the windows we have been looking through are called **filters**. Filters can also be made of other materials such as glass.

A red filter lets red light through and **absorbs** light of other colors. A blue filter lets blue light through and absorbs red and all other colors. A green filter lets through only green light, etc. In summary, **a filter lets through light of one color (its own) but absorbs the rest.**

The rules for filters are very similar to the rules for the reflected light from other objects; filters let light of one color pass through to our eyes while colored objects **reflect** light of their color to our eyes.

Optional: *A deeper analysis of filters for older groups:*

Rarely do we ever see absolutely pure colors of light.

There is no such thing as a “perfect” filter; a perfect filter lets through only one color of light. Our green filter on the flood lights lets through a little bit of blue light, in addition to the green light. Let’s see which of the filters in our paddles is nearest to “perfect.”

Switch on blue light only.

Do the red or green filters let through any of the blue light? *(The green filter does. The red does not.)*

Turn off blue; turn on green.

Do the red or the blue filters let through any of the green light? *(The blue filter does. The red is still black.)*

Turn off green; turn on red.

Do the green or the blue filters let through any of the red light? *(Not much.)*

Which is the best filter? *(Red, because it lets through only red light.)*

Which is the worst filter? *(Blue, because it lets through quite a bit of green light.)*

Colors From Space



Image 1: Mars with red filter

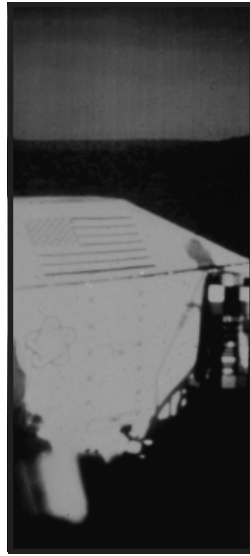

Image 2: Mars with blue filter

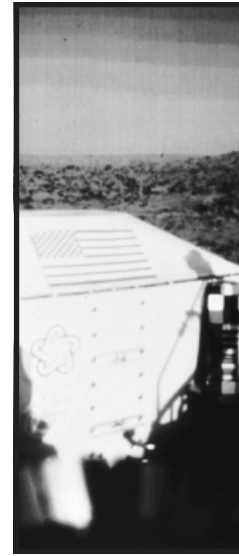

Image 3: Color picture of Mars

Astronomers, engineers and scientists use filters in various ways. For instance, here's a picture of Mars taken by the Viking spacecraft.

Image 1: Mars with red filter.

This picture was taken with a black and white camera and a filter. **What color filter was it? (Red.)** Then, the Viking took a picture of the same scene with a blue filter.

Image 2: Mars with blue filter.

The camera viewed the same scene also with an amber filter. The Viking spacecraft sent all the information to Earth where NASA scientists used computers to put the pictures together to get a color picture of Mars taken with a black and white camera!

Image 3: Color picture of Mars.

A color TV set works in a similar way. It receives pictures of only red, green and blue and your set puts it together. The U.S. flag you see on the spaceship was used to adjust the colors to the right mix, by comparing it with an identical flag on Earth.

Let me show you how astronomers can use filters to learn more about the things they see in space. Sometimes they can see much more contrast, and finer detail, by selecting only one color.

Image 4: Jupiter through red filter.

Do you recognize this planet? (Jupiter.) It's easy to tell Jupiter with its Great Red Spot. But wait! Where's the red spot? This picture was taken with a a filter. **Can you guess what color filter? (It was red.)** All areas of Jupiter reflecting red light look bright in this image. A blue filter

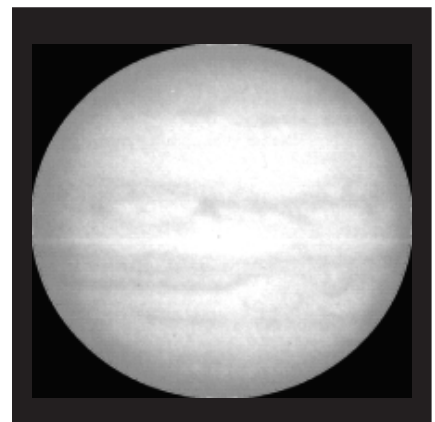

makes some features stand out, easier to see as you can see in this same picture taken with a blue filter.

*Image 5: Jupiter through red filter.
[Note: images 4 and 5 can be replaced by having a color image of Jupiter and having students look at the image through their color analyzers.]*

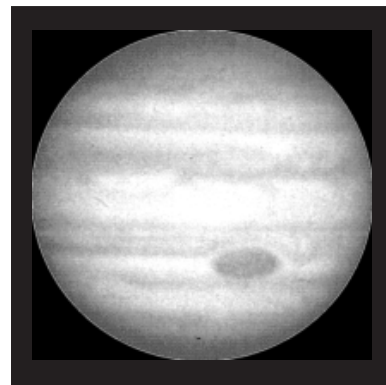

Notice the red spot appeared, other features now look dark and stand out. So, different filters can make different details stand out. Here's a series of pictures of The Ring Nebula in Lyra, a gigantic cloud of dust and gas in space. Ring shaped nebulae (planetary nebulae) are believed to be remains of very old stars. These pictures were taken with different filters, each of them showing different details.

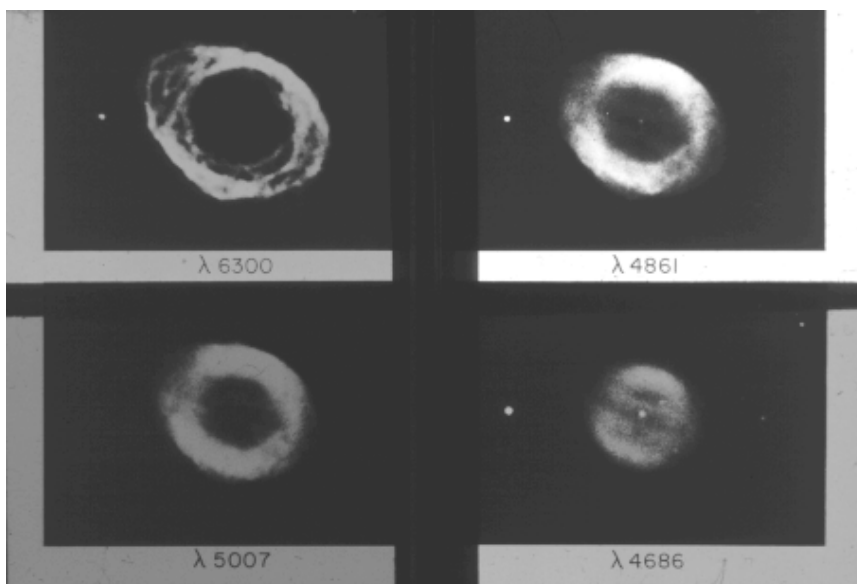

Image 6: Ring nebula through Red, yellow, green, and blue filters

Now the composite picture.

Image 7: Composite Color Picture.

Optional: Show the sequence of images 6a-d again, saying the filter colors, so that the students have another chance to see the successive inner regions of the nebula revealed.

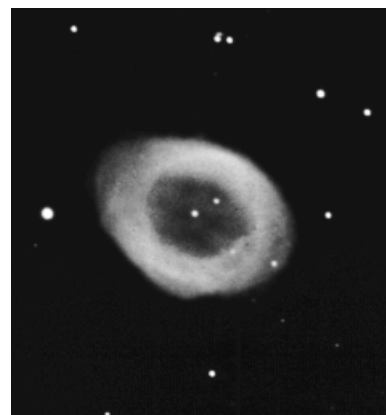

Image 7: Ring nebula in color

Diffraction Gratings

Using filters is one way of separating light into its individual colors. Another way of separating light into its component colors is using a “diffraction grating.” Window **D** in your color analyzer is not just a clear window, it is a piece of plastic with thousands of parallel grooves; it is called a **diffraction grating**. When light goes through the grooves the light splits into different parts, so we can see what makes up the original light. Look directly at this light in the center through window **D**, holding it very close to your eye.

Gradually turn on the variable white light in the center. Demonstrate how to look through the diffraction grating. Then, check that everyone’s face is directly illuminated by the light from the bulb.

What do you see? (A straight rainbow.) Besides the white light in the center you can see rainbows when you look to the left and right of the bulb. Rotate your color analyzers until the rainbows appear to the sides. **Let’s name all the colors we can see through the diffraction grating starting from the one furthest from the light.** (Red, orange, yellow, green, blue and purple or violet; have the whole class say the colors.) Those are the colors that make up this white light. The diffraction grating allows us to see that white light is a combination of many colors: red, orange, yellow, green, blue and violet. But these are just the colors we can see. There are lots of other colors we cannot see; for instance, there is one before the red, called “infrared,” and there is one after the violet called “ultraviolet.” The areas before the red and after the violet look dark to us even though the invisible colors are there.

Optional:

Filters are one way to separate light into its individual colors. Another way to do that is to use a prism which, as you know, creates a rainbow. Here I have a source of white light passing through a slit.

Turn on slide projector with slit. A line of white light should appear on the dome.

Now I am going to put a prism in the path of that white light.

Move prism to the right place to produce a rainbow on the dome.

Notice that the rainbow doesn’t appear in the same place as the white light. It shifted position because the prism bends the path of the light going through it. But all the colors that are making up the white light are bent different amounts; violet is bent the most, red the least, so all the components of white light are separated. Again we see the rainbow colors: Red, orange, yellow, green, blue and violet. Our eyes are not sensitive to the invisible colors such as infrared and ultraviolet.

Use light pointer to indicate where infrared and ultraviolet would appear if we could see them.

What Stars Are Made Of

Astronomers use diffraction gratings to discover what stars and other glowing objects are made of. They do it by analyzing (or breaking apart) the light that comes from a star. Some stars give off light like this.

Put the hydrogen tube on its power supply, turn it on and turn off the white light. Make sure that everyone has a chance to see the hydrogen light. CAUTION: POWER SUPPLY IS HIGH VOLTAGE!

Look at this light through your diffraction grating. *Can you see the whole rainbow?* (No, only 3 lines: red, green-blue and purple.) Only a gas called **hydrogen** gives off this combination of colors when it gets very hot. A set of colored lines like these is called an “emission spectrum.” So, when astronomers find this particular set of colors in the light of a star, they know that star has hydrogen in it. Most stars in the universe are made mostly of hydrogen. I would like you to remember this set of colors or **spectrum**, for two reasons: one, to compare with the spectrums (or spectra) from other gases that I am going to show you in a moment, and two, to be able to identify a mystery gas.

Display hydrogen again for a few more seconds, then replace the hydrogen tube with the helium tube and display it in similar way.

Sometimes the light from stars looks like this. *What colors do you see now?* (Red, yellow, green, purple.) Those are the components of the light from **helium**. Many stars have helium in them. The hydrogen that “burns” in the stars changes into helium. Remember this spectrum, too.

Replace the helium with the neon tube and display it in a similar way.

Older stars have a gas that glows like this. This is **neon**. *What colors do you see through your diffraction grating?* (Red, orange, and yellow lines ... and a green line.) Using diffraction gratings scientists can decode the information that comes in the light from stars and know what they’re made of. Also, by looking at how much of each element a star has, scientists can determine the approximate age of that star—in millions or billions of years.

You can show other gases if you wish. Then pick one “mystery tube,” put it on the power supply, and display it. In the following paragraph, the instructor uses water vapor as the mystery gas.

And here’s the mystery gas!! If you were an astronomer trying to identify the contents of a glowing gas like this, you would compare its spectrum with spectra of gases you already know. *Is this spectrum similar to a spectrum you have already seen?* (Yes, similar to hydrogen.) The gas in this tube is made mostly of hydrogen. The other component is oxygen. *What is made with two parts of hydrogen and one of oxygen?* (Water.) The gas in this tube is water vapor, its spectrum is very similar to hydrogen’s.

Turn off power supply.

Invisible Colors

When we were looking at the spectrum of white light (the rainbow) we noticed that we cannot see any colors beyond violet or red, but there are actually colors there. Special instruments and special photographic film can detect them. Besides ultraviolet and infrared there are many, many other colors of light. Maybe you have heard of “radio waves,” “X-rays,” and “cosmic rays.” All those are invisible colors. Astronomers have developed telescopes that can see in all of these colors, and we are learning much more about the universe this way. Some animals can see these invisible colors too, and beings on other planets might have eyes that could see colors that are invisible to us. Let’s look at some pictures that relate to invisible colors:

Images #8-20 are arranged to illustrate the “invisible colors,” first from UV to X-ray, then from IR to Radio. Format for each “color” is:

- a. A well known, everyday example of a device that uses the invisible color.*
- b. An instrument that detects the invisible color.*
- c. An astronomical image produced by such an instrument, with the aid of a computer.*

Image 8: Ultraviolet - Suntan

UV rays cause suntans and sunburns. Here we see a person sunbathing, getting a tan. The ultraviolet light that comes from the Sun is responsible for giving us tans. The atmosphere, in particular the ozone in the atmosphere, filters out most of the ultraviolet light from the Sun. Visible light doesn’t go through clouds very well, but ultraviolet can go through clouds. That’s why we can still get sunburned on a cloudy day—we use sunscreen to filter out ultraviolet light before it reaches our skin.



Image 9: UV Satellite

Because the air filters out a lot of ultraviolet rays, in order to have a clearer view of space in ultraviolet light we need to have ultraviolet observatories up in space, above the atmosphere. This is called the Far Ultraviolet Spectroscopic Explorer [Orbiting UV Observatory if laser disc image is used].

Image 10: Venus in UV.

Here’s a picture of Venus in ultraviolet light. Remember, we cannot see ultraviolet with our eyes. This image is processed by a computer using familiar colors to indicate different shades of ultraviolet.

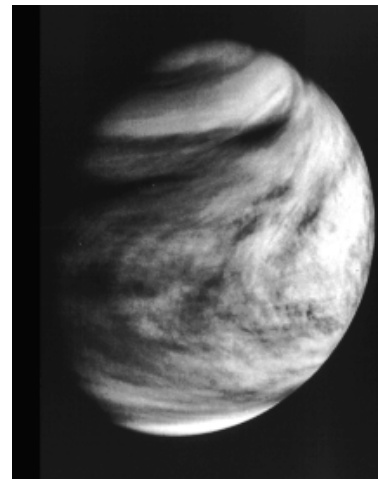
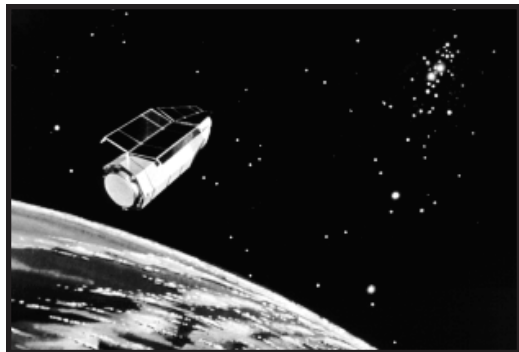
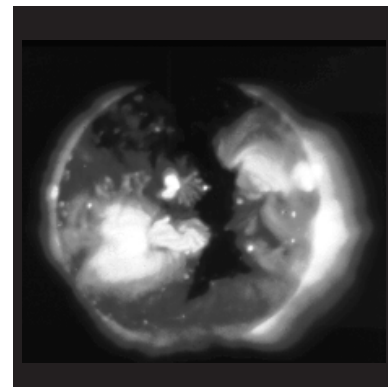

Image 11: X-ray

You may have seen a picture like this before. **What is it?** (An X-ray.) The X-ray is another invisible color and it can go through some things that visible light cannot. **Can X-rays go through air and through flesh?** (Yes.) That's why the flesh of the hand doesn't show. But bones can filter out X-rays better and they leave their "shadow" on the X-ray-sensitive plate.

*Image 12: HEO-2 Einstein X-ray Observatory Satellite*

There are many sources of X-rays in the universe but they are hard to "see" through the atmosphere. Skylab, a laboratory in orbit several years ago, used this X-ray telescope to look at objects in space, especially the Sun.

Image 13: X-ray Sun

Stars give off a lot of X-rays. Again, this picture is computer-processed to show the different brightness levels of X-rays. There are some objects in space that give off very little visible light but a lot of X-rays. Those would be invisible to our eyes but visible only with instruments.

Image 14: Electric Heater

In many homes there are devices that produce a lot of infrared rays, plus some visible red or orange. **What is this?** (A heater.) Infrared is another invisible color that our eyes can't see but we can **feel**. Infrared feels like heat.

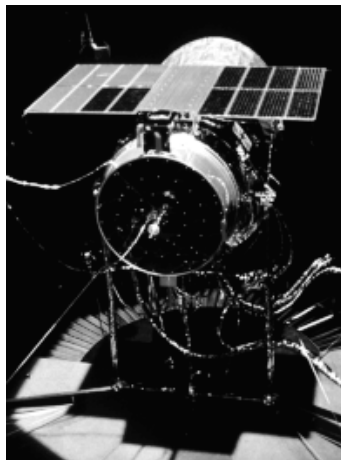

Water is an **excellent** filter to infrared radiation. Infrared rays that come from space are stopped by water molecules in the air. Infrared observatories must therefore be at high altitudes so they are above most of the moisture in the atmosphere.

*Image 15: IRAS*

You probably suspected this, too: infrared observatories in space. How much higher can you get? Well, we probably could get higher but it wouldn't make much difference since this telescope, IRAS, is above all of the water vapor in the atmosphere.

Colors From Space

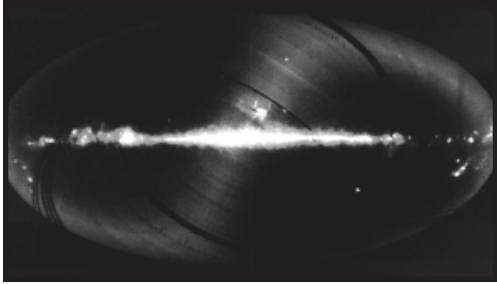

Image 16: IR Scan of Milky Way

Here's a picture of the infrared radiation (heat) that comes from our galaxy, the Milky Way.



Image 17: Microwave Oven

Alright! Another household item! **What is this?** (*Microwave oven.*) Microwaves are another invisible color! Did you know that you can cook your food by shining some colored light on it?

Image 18: Radio Towers

Microwaves are really a special form of radio waves which we can use for communications. These radio towers can have rock music blasting all around by sending it in the form of radio waves.

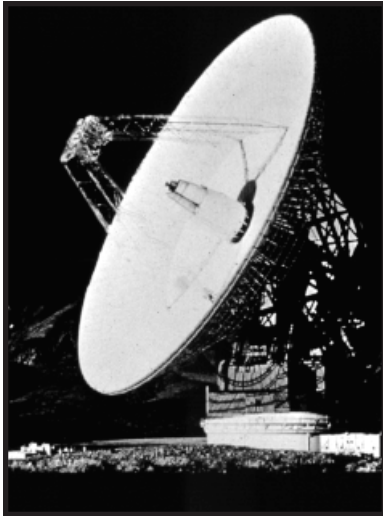
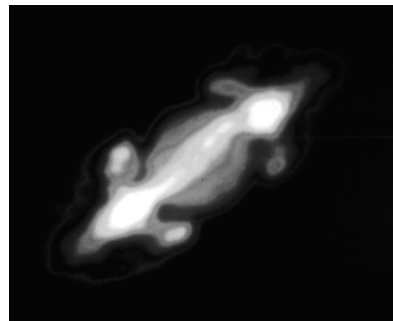

Image 19: Radio Telescope

A radio dish antenna can be used to receive radio waves from space. Is rock music what we'll hear when we point our radio telescopes at space?

Image 20: Radio Map of Jupiter

Nope! No rap aliens yet. This is a picture of Jupiter showing the enormous amounts of radio energy coming from the powerful magnetic fields that surround this giant planet. To "radio eyes," Jupiter appears to have a strange shape indeed!



Optional (for older students):

We've said that we can look at space in the invisible ultraviolet with the help of instruments. But some objects in space are natural detectors of ultraviolet light, converting it into visible light that we can see through "normal" telescopes. This is the case with red-glowing nebulae, called "emission nebulae."

Image 21: Trifid nebula

Nebulae are clouds in space, made of mostly hydrogen. There are three types of nebulae: red, blue and dark. The red colored gas clouds are not actually being illuminated by red light from nearby stars; they are being illuminated by ultraviolet light which they absorb and convert into red light. This process is called **fluorescence**. A gas that can make this conversion is hydrogen. Red nebulae are mostly made out of hydrogen. Astronomers found this out by analyzing their light. **With what?** (*Diffraction gratings, of course!*)

The blue nebulae are made mostly of dust and hydrogen. They are not fluorescent. They get visible light from nearby hot stars. The dust reflects the light, especially blue, which we can see. These are called "reflection nebulae."

The dark nebulae are made mostly of dust that stops the light coming from stars on the other side.

Some nebulae appear white because they give off several colors at the same time.



The Secret Message (in UltraViolet Light)

Turn on white light in the center of the room, have bottle with tonic water ready.

In a moment, I am going to turn on some special lights that contain blue, violet and ultraviolet light. We will see the blue-violet but we cannot see ultraviolet; we may detect the ultraviolet by looking at certain objects in this room. Besides hydrogen, there are many other natural detectors of ultraviolet light. Here I have a bottle with "tonic" water, the kind that you buy in a store to drink.

Display the bottle.

It looks like "normal" transparent water under this white light, but when I turn on the ultraviolet light, the chemicals in water will glow in a special way. This phenomenon is called "fluorescence." Certain chemicals in the water absorb the ultraviolet and reradiate it as visible light, just like the nebulae in the pictures we just saw.

Colors From Space

Turn on the UV lights; turn off the white light and display the bottle again. Some children's clothing will fluoresce because of dyes or chemicals used in laundry detergents to "brighten" the clothes. The sun's ultraviolet rays causes the "brighter-whites-look" outside. Sometimes even teeth will fluoresce if a student gives a nice toothy grin. Have they been using fluoride toothpaste?

Optional: *Display object with fluorescent paint.*

Here I have an object painted with fluorescent paint. Also, look on your color analyzers; you will find a dark strip with a secret message written on it with invisible fluorescent ink. Read it to your neighbor.

After a minute or so, turn off fluorescent lights, turn on same lighting as it was for entrance.

When we think of the wide range of colors in the universe, the few visible colors and the very many colors invisible to our eyes, it is apparent that we humans are nearly blind to most of what's happening around us. Only by developing better instruments and techniques can we overcome our limited sight.

Before we go, are there any more questions about colors, light, space or things related to this program?

Wait several seconds looking around the planetarium for any raised hands. Answer questions in familiar "Colors from Space" terms.

Thank you all for visiting with us today. On your way out, please deposit your color analyzers in this box.

Show box, then place box near the exit.

I hope all of your colors may be happy.

Discover More About Colors From Space

Worldwide Web Connections

and update information may be found at <http://www.lhs.berkeley.edu/pass>

Apfel, Necia H., *Astronomy Projects for Young Scientists*, New York: Prentice-Hall Press, 1984. 120 pp., paperback \$6.95, Grade level: 7-up. A collection of astronomy projects: building a theodolisk; sundials; telescope making; spectroscopes; planetariums; models; observing the sun, moon and planets; and variable stars. Includes an appendix of resources, contests and competitions.

Asimov, Isaac, *Astronomy Today*, Milwaukee, WI: Gareth Stevens Publishing, Isaac Asimov's Library of the Universe, 1990. 32 pp., hardbound or paperback, Grade level: 3-6. Discusses telescopes of modern astronomy, the space telescope, radio astronomy, the electro-magnetic spectrum as a tool of modern astronomy, and backyard astronomers. Includes a "Fact File" reference section, a bibliography, a glossary, an index, and color photos and artwork.

Darling, David J., *The New Astronomy: An Ever-Changing Universe*, illus. Jeanette Swofford, Minneapolis: Dillon Press, Inc., Discovering Our Universe Series, 1985. 55 pp., PLB \$10.95, Grade Level: 3-6. It starts with a question and answer fact section about modern astronomy, and goes on to explain signals from space, the radio telescope revolution, the use of the electro-magnetic spectrum in modern astronomy, x-ray astronomy, spectroscopy, gamma ray astronomy, ultra-violet astronomy, infrared astronomy, the big bang, and the space telescope. It includes a glossary, a bibliography, and an index.

Darling, David J., *The Stars: From Birth to Black Hole*, illus. Jeanette Swofford, Minneapolis: Dillon Press, Inc., Discovering Our Universe Series, 1985. 55 pp., PLB \$10.95, Grade Level: 3-6. It starts with a question and answer fact section about the stars, and goes on to explain the life and death of a star, twin stars, giants and dwarfs, constellations, clusters, galaxies, and facts about well-known stars. It includes a glossary, a bibliography, and an index.

Gallant, Roy, *Fire in the Sky: The Birth and Death of Stars*, illus., New York: Macmillan, Four Winds Press, 1978. 130 pp., hardback \$7.95, Grade Level: 7-up. It discusses the characteristics of star using the sun as an example, covering the composition of the sun, various theories about its energy production, differences among the stars, the birth and death of stars. It includes a glossary and an index.

Gianopoulos, Andrea. "Enlightenment" in *Astronomy*. June, 1999, p. 50.

O'Meara, Stephen James. "The Colors of Mars: Reality and Illusion" *Sky & Telescope*. April, 1999, p. 86.

Young, A. "What Color is the Solar System?" in *Sky & Telescope*, May 1985, p. 399.

See also *Planetarium Activities for Student Success, Volume 3, Resources for Teaching Astronomy and Space Science*, sections on **General Astronomy**, page 23, and **Invisible Astronomy**, page 24.

*Colors
from
Space*

*Classroom
Activities*

Mixing Colors

This activity was designed for elementary school aged children. The students use food coloring in water to experiment with mixing different color pigments. They compare this to the mixing of different colors of light. It can easily be adapted for older students.

Objectives

This activity makes students aware of the difference between mixing pigments of different colors and the mixing of light of different colors. After this activity, students will be able to:

1. Tell which combinations of primary pigment colors are necessary to create particular secondary colors and hues.
2. Tell what colors are produced by particular combinations of colors of light.
3. Recognize that there is a difference between combining colors of pigments and combining colors of light.

Materials

For Each Pair of Students:

- 4 plastic cups
- 1 plastic bowl
- 4 "Color Mixing" worksheets (master on p. 27)
- 1 set of crayons
- 2 stiff white cardboard squares (about 4"x4")
- 2 scissors
- 2 short pencils (sharpened)
- glue and/or tape
- 1 tack

For the Whole Class:

- Food coloring (Red, Blue, & Yellow)
- 3 large beakers of water
- 3 white floodlights (75 watt) with clamp on light sockets and metal reflectors or 3 bright flashlights
- 1 filter gel of each of the following colors (each large enough to cover the front of the lamp reflector or flashlight; gel material sold at theater supply stores)
 - Medium Red - # 27, Kelly Green - #94
 - Medium Blue - #88





Before Class





1. Make three large beakers of colored water by adding several drops of food coloring to water in the beakers. Make one beaker of yellow, one of red, and one of blue.
2. Secure the color filters to their respective light sources.
3. Draw a 4" circle on each cardboard square.
4. Try making a color wheel top or two before class. Experiment with different color combinations so that you get a feel for what proportions work best.





Note: Younger students should use crayons to indicate the colors they see on the worksheets (master on page 27). Older students can write their results on a blank sheet of paper.





EXPERIMENT WITH **PIGMENT** OR **LIGHT** (circle one)

COLOR MIXING

 +  =  Prediction
 Test Result

 +  =  Prediction
 Test Result

 +  =  Prediction
 Test Result

 +  =  Prediction
 Test Result

Your Name _____

In Class

Part A: Mixing Pigment

Suppose we have only red, blue and yellow paint, but we want to paint our room green. *Is there any way we can make green paint from what we have?* Let's do some experiments to find out.



1. Students work in groups or pairs. Hand out four clear plastic cups and one plastic bowl to each pair of students.

2. Have students predict what color they will make with each combination of two colors. Use "Color Mixing" record sheets and crayons for recording predictions.

3. For each pair of students, pour one of each primary color water into plastic cups.

4. Let the children test their predictions and record the results on their color mixing sheets. Explain to your students that they should discard test results in the plastic "discard" bowl before attempting a new test.

5. Lead a class discussion and summarize the class results on the chalkboard by Venn diagrams of color mixing:

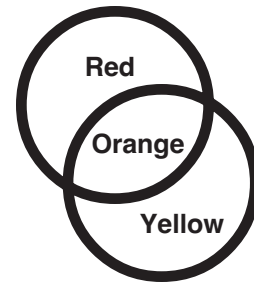
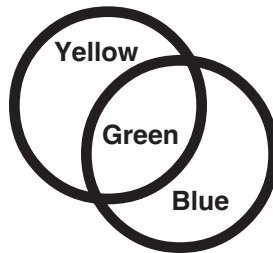
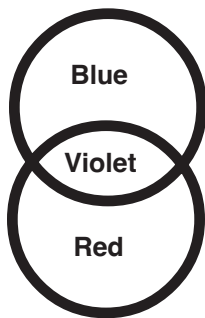

Part B: Mixing Colors of Light

Now let's see how colors mix when we use the **light** itself for mixing and not pigments. We have three light sources: red blue and green.

Darken the room. Demonstrate each light by shining it on a white screen or white wall (Off white is OK, too).

What color do you think we will get when we mix the red light and the green light together? The red light and the blue light? The blue light and the green light? Please indicate your guess by filling out another color mixing worksheet.

Allow time for students to record their guesses. You can shine the different color spotlights on a screen or wall, but be sure the beams of light don't overlap and mix until all students have recorded their guesses. When all students have recorded their guesses, mix the light beams in the three possible pair combinations, one at a time, and have students record the observed result on their worksheet. Finally mix all three light beams together. Ask the students: Why do the three colors appear white? (White is made up of all colors of light.) What colors of light do you think we will need to make black? (None. Black is the absence of light.)

For older students, ask if they can explain why we get different colors when mixing pigments compared with mixing lights. If they have seen the planetarium program *Colors From Space*, they may be able to figure out that when mixing two pigments, each separate pigment absorbs all but a few colors, so when they are mixed together, we see only the colors that are not absorbed by both pigments. However, when colored lights are added together, we see the combined colors of all of the lights that are being added.

Part C: Color Wheels

Now we will mix colors another way: on a spinning wheel!

1. Hand out cardboard and scissors. Have the students cut out the circles.

2. Have your students use crayons for making a design on their cardboard circles. The design that works the best is pie slices. What size should each pie slice be to produce the whitest color when you spin the disk? Experiment to see what works best. Hint: don't use too much red.

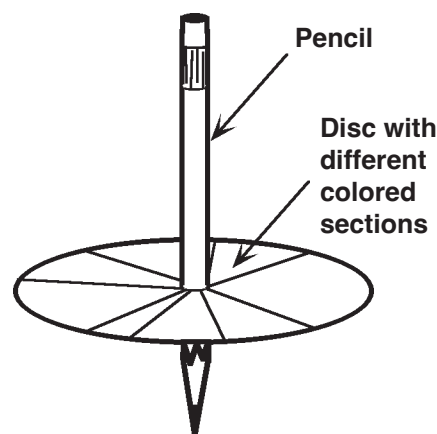

3. Show your students how to use a tack to start a small hole in center of the circle for a pencil to stick through. Secure a pencil in the hole with tape and/or glue. Make the paper disc fairly close to the tip end of the pencil (within an inch).

Now spin it. (it stays upright) Look at the colors while the top is spinning fast. **What color do you see?**

Is the color we see on the spinning top more like mixing pigments or more like adding colored lights? (More like adding colored lights because we are seeing the combined colors reflecting from all the colored areas on the top.)

Colors From Space

Summarize: White is the combination of all colors of light. A rainbow is white light broken up into its component colors by little droplets of water in the air.

The distinction between colors of light and colors of pigments may be difficult for younger students to comprehend. **Light** can travel through space and illuminate pigmented objects that either **reflect** or **absorb** the light. **Pigment** in an object causes the object absorb all colors of light except the color of light for which the pigment is named. For example, red pigment (paint, crayon, etc.) absorbs all colors of light except for red light. In the absence of any light, all pigments appear black.

The absence of light appears to us as the color black. If you look through a hole in an otherwise closed box that has a white interior surface, the inside will appear dark. This demonstrates how the absence of light can make even a white surface appear black.

Going Further with Filters

1. We highly recommend the set of activities entitled “Color Analyzers” from the Great Explorations in Math and Science (GEMS) science curricula from Lawrence Hall of Science. The guide comes a class set of red and green colored filters and diffraction gratings.
2. If you are able to get a class set of filters, your students can find out more about how filters work. Have your students observe the effects of filters on various color images as well as finding out the effect of combining different color filters. Collect a number of large color pictures, posters, and/or slides of a variety of subjects. For each poster or slide, have your students view the picture through each of their color filters. Lead a discussion about how the filters change the appearance of the picture and how filters can help resolve particular details in the picture. Have your students write down on paper which particular details of the picture show up best with a given filter.
3. Your students can experiment with all possible combinations of filters: red+green, red+blue, and blue+green. With extremely good filters, any combination of different colors will not let any light through, so everything appears black. Since real filters vary considerably in quality, different combinations will let more or less light through.
4. **Which is the best filter?** Try a variety of filters with a set of standard color lights. The challenge is to find a filter which make all color lights look dark except the color light that matches the filter color. The other side of the coin is that any color light does not give off a perfectly pure color of light (single frequency). So even if you were able to get a “perfect” filter, it would probably let light through from an imperfect (not pure color) light source. The closest thing in existence to a pure color light source is a laser.

Spectroscopes

In this activity, students build simple spectroscopes with which they can quantitatively analyze emission spectra of elements and compounds.

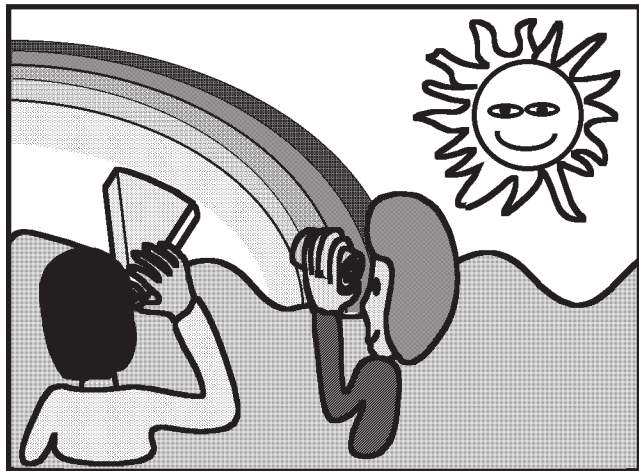

Objectives

The elementary version is best used with younger classes (grades 2-6), while the advanced version is most appropriate for older classes (grades 6-9). In this activity, students will be able to:

1. Build a spectroscope.
2. Record the spectrum lines in emission spectra of elements.
3. Distinguish elements and compounds by examining their emission spectra.

Elementary Version

Materials

For each student:

- 1 square of diffraction grating (1")
- 1 cardboard tube, about 2" dia. x 4" long
- 2 railroad board squares, about 2-1/2" on a side
- 1 roll of clear tape
- 1 box of crayons containing red, orange, yellow, green, blue, violet
- 1 spectra worksheet (master on page 35)
- 1 scissors
- 1 pencil

For the class:

- 1 Light bulb (ideally, tubular, unfrosted) & socket

Optional:

- 1 Spectrum tube power supply*
- 1 Spectrum tube of each of the following gases:*
Hydrogen, Mercury, Helium, Water, Neon.

Even if you don't have access to spectrum tubes and power supply, this activity can be done by having your students construct their spectroscopes, observing various light sources, and comparing them with prepared posters of spectra of these elements as shown at the top of page 32.

* See page 4 for sources

Colors From Space

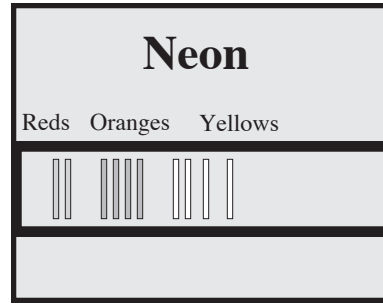
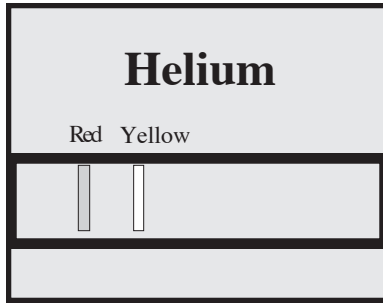
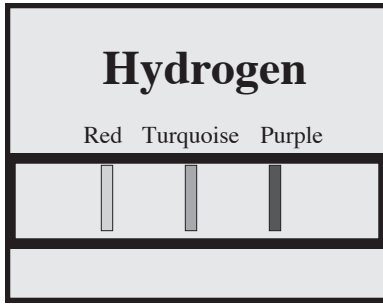

Before Class

1. Drill or punch a 3/4" hole in the center of half the railroad board squares. Drilling is most neatly accomplished with a drilling jig or by stacking the squares all together and sandwiching them between two pieces of scrap wood.
2. Gather all other supplies. For each student, make a copy of the worksheet.

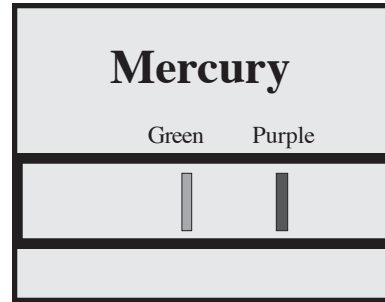

In Class

1. One of the most important tools of the astronomer is a spectroscope which breaks light up into various colors. With spectroscopes, astronomers can tell what stars and comets are made of, and what's in a planet's atmosphere without having to go get samples. Getting samples, especially from stars, is impossible anyway. To see how a spectroscope works, each student will make his or her own simple spectroscope.

2. Making a spectroscope (For each step, demonstrate before handing out materials for doing the step.)

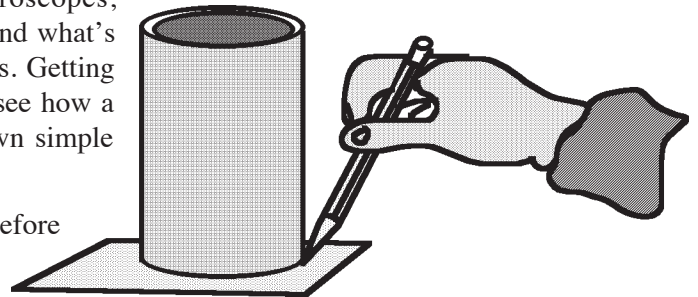

- (i) Using the cardboard tube as a guide, draw circle outline on the railroad board square with the 3/4" hole in the center.
- (ii) With scissors, cut out the circle.
- (iii) Tape the diffraction grating square over the 3/4" hole, without covering the hole with tape. Caution your students to handle the diffraction grating square by the edges and not to get fingerprints on it.
- (iv) Tape the result of step 3 onto one end of the cardboard tube.

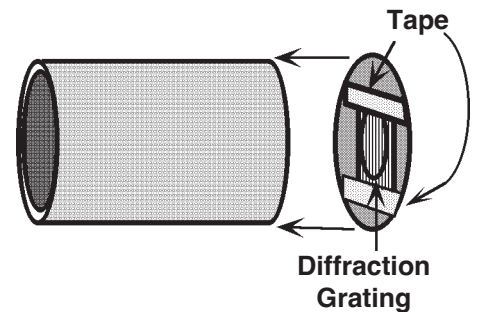

Optional:

- (v) Draw a circular outline of the tube on the second railroad board square, as in step (i), but without a hole in the center.
- (vi) Cut out the disc, and cut the disc in half.
- (vii) Tape the halves of the disc onto the end of the tube opposite the diffraction grating so that there is an approximate 1/8" slit between the halves. **Tape the half-discs so that they form a slit perpendicular to the direction of the color bands.**

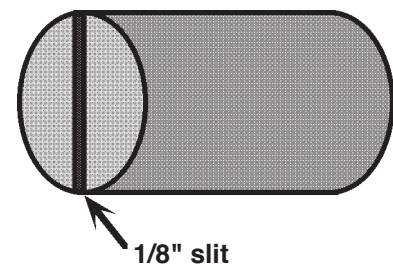

Turn on the bright white tubular unfrosted light bulb in the center of the room.

What do you see when you look through your spectroscope?
(Rainbow colors)

Make sure the students hold the diffraction grating ends close to their eyes. Check with each student to see that they do in fact see a rainbow of colors. Tell the students that the best way to see the colors is to turn the spectroscope until a big wide band of colors is seen spreading out to the sides.

What color is closest to the light? (Purple.) **What color is next to that?** (Blue.) **Next?** (Green.) **Next?** (Yellow.) **Next?** (Orange.) **And finally?** (Red.)

Tell your class that the colors of a rainbow are always in the order they see here. Suggest that they notice that next time they see a rainbow in the sky. Have the whole class repeat together the colors of the rainbow as they see them in order from purple to red. Just for variety, have the whole class say the colors in order backwards (from red to purple).

A metal filament (usually tungsten) is giving off light inside the bulb. Since stars are made of gases, we are interested in seeing gases glow.

Optional: Show the spectrum tube (hydrogen)

In that tube is a gas called hydrogen, commonly found in stars. The tube can be made to glow by using the 10,000 volt light bulb socket (power supply). Hold your spectroscopes so that the colors spread sideways.

Turn the bright white light back on for them to readjust how they are holding their spectroscopes. Then turn the white light off and turn the hydrogen tube on.

How is this light different from the white light? (There are only certain thin lines of color.) **What is the brightest color line?** (Red.) **What are the two next brightest color lines?** (Turquoise and purple.)

Now hand out crayons and worksheets and have your students color what they see as the spectrum of hydrogen. Tell them how to spell hydrogen in the line next to "ELEMENT 1." Show the helium, neon, and mercury spectrum tubes and in each case, ask what the most prominent lines are and have your students color them on their worksheets.

Colors From Space

Every gas has a different “signature” of colors. This is how astronomers can tell what gases are in a star, comet, or planet atmosphere just by looking at the light through a spectroscope. You can see interesting spectra with your spectroscopes if you try looking at street lamps, neon store signs, and other bright light sources. Never look directly at the sun. [The sun displays a brilliant rainbow through the spectroscope but one must be careful to tilt the tube to one side and look only at the side of the tube farthest from the sun so that one is not looking directly at the sun through the end of the tube.] A safe way to observe the spectrum from the sun is to allow the sunlight to shine through the spectroscope and onto a piece of white paper or cardboard. You can observe an excellent spectrum right on the paper without having to look directly toward the sun.

*Homework assignment: use your spectroscope, crayons and paper to record the spectra of (1) a streetlight, (2) a restaurant sign, (3) a fluorescent light. **Can you identify the elements in the spectra you have drawn?***

Drawing Spectra

Red	Orange	Yellow	Green	Blue	Violet
Element 1: _____					

Red	Orange	Yellow	Green	Blue	Violet
Element 2: _____					

Red	Orange	Yellow	Green	Blue	Violet
Element 3: _____					

Red	Orange	Yellow	Green	Blue	Violet
Element 4: _____					

Red	Orange	Yellow	Green	Blue	Violet
Element 5: _____					

Red	Orange	Yellow	Green	Blue	Violet
Element 6: _____					

Spectroscopes—Advanced Version

How to build and use a

Spectrometer

Materials

For each student:

- 12" x 16" darkly colored railroad board
- 9" cardboard tube 2" wide on the outside
- 1-3/4" cardboard tube 2" wide on the inside
- 2-1/4" cardboard disk with 1/4" hole in the center
- 1" square diffraction grating* (13,400 grooves/inch; not holographic)
- masking tape
- opaque tape (no light comes through)
- scissors and/or a sharp blade (be careful)
- wavelength scale (photocopy scales on page 41)
- pair of marking template sheets (masters on pages 42-43)

* Available from science supply companies such as Edmund Scientific Co., 101 E. Gloucester Pike, Barrington, NJ; Frey Scientific, 905 Hickory Lane, Mansfield, OH 44905, (800) 225-3739; Science Kit & Boreal Laboratories, 777 E. Park Dr., Tonawanda, NY 14150-6784, (800) 828-7777. Optionally, you can use holographic diffraction grating, but the spread of colors will be narrower, so you would have to reduce photocopy the wavelength scale to calibrate for accurate readings.

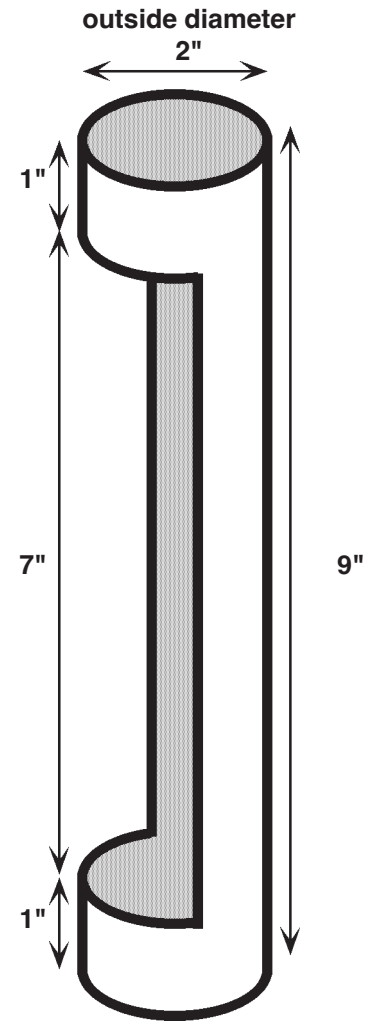
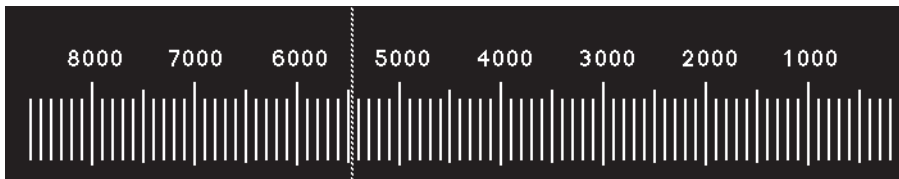

Preparation

Photocopy the scale pieces. Make a marking template for the body of the spectrometer by photocopying the two parts on pages 42-43, cutting them out, and taping them together, making the arrow heads overlap exactly. Cut the cardboard tubes to proper lengths. Half of the 9" tube must be cut away, but only the central 7". An inch of tube at each end must remain intact. Cut out cardboard disks and, with a hole punch, punch holes in the centers.

In Class

A Spectrometer - What Will It Do?

Our eyes perceive light in different colors. Some of the colors that we see are pure colors, but most of the colors we see are mixtures of different colors. A **spectrometer** can separate light that is a mixture of colors into a collection of pure colors. A collection of pure colors is called a **spectrum** (for more than one spectrum say spectra).

A spectrum that many people are familiar with is the one created when the pure colors that make up sunlight are separated as they shine on raindrops. It's a rainbow! The colors in a rainbow include every pure color that human eyes can see. Many of the spectra that the spectrometer shows you may look like rainbows. Some lights, however, produce only a few pure colors of light. Knowing what these colors are can give you information about what substances are giving off the light.

The spectrometer can give a measurement to describe each pure color. The spectrometer measures the color's **wavelength**. Light travels as a wave. The length between two crests of a light wave, its "**wavelength**," determines what color it is. Light that is a mixture of different wavelengths is not a pure color and will be separated by the spectrometer. Wavelengths are very small so inches or centimeters are impractical for describing wavelengths. The spectrometer measures wavelengths in Ångstroms. One Ångstrom (abbreviated, 1Å) is one ten-billionth of a meter. A typical visible lightwave is a few thousand Ångstroms. You can use the spectrometer to see how long the wavelength is for different colors of light. (Another common way to describe wavelengths is in nanometers, but most standard American reference books use Ångstroms. Conversion is very simple: 1 nm = 10 Å)

Putting it together:

To assemble the eyepiece of the spectrometer tape the cardboard disk to one end of the 1-3/4" cardboard tube. Use plenty of tape to make it strong and to keep light from leaking in through any cracks, but make sure that the tape is on the **outside**. The inside must slide freely over the end of the 9" tube. Next tape the 1" square of diffraction grating material over the hole in the disc. Be careful not to let tape cover the hole itself. Look through the hole at any bright light. (Not the sun!) Already it is possible to observe spectra. Bright lights in dark places work best. To observe spectra more clearly and to measure wavelengths you will have to build the body of the spectrometer.

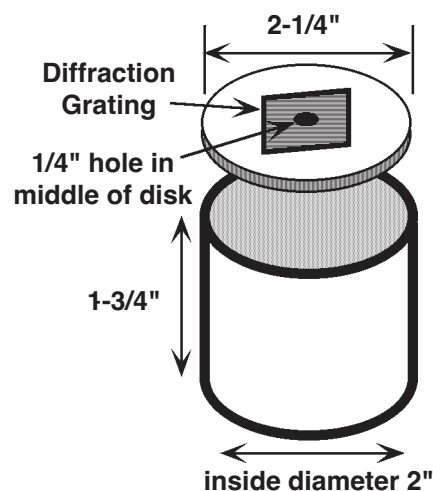

The body of the spectrometer should be cut out of dark railroad board. Its outline can be traced onto the railroad board from the body template (master on pp. 42-43). The slot that is 1/4 inch wide is where the light shines into the spectrometer. Use the opaque tape to make this slot into a narrow slit. The narrower the slit, the more accurate the measurements can be. The wider the slit, the brighter the spectrum will appear. A slit 1mm wide is good. Use tape on both sides for extra strength.

Colors From Space

The other slot is the window for the wavelength scale. The wavelength scale must be cut out exactly along its edges. Tape it face down over the window so that its edge is exactly along the narrow slit but not covering it. Make sure that no tape covers either the slit or the window. It will appear as pictured below.

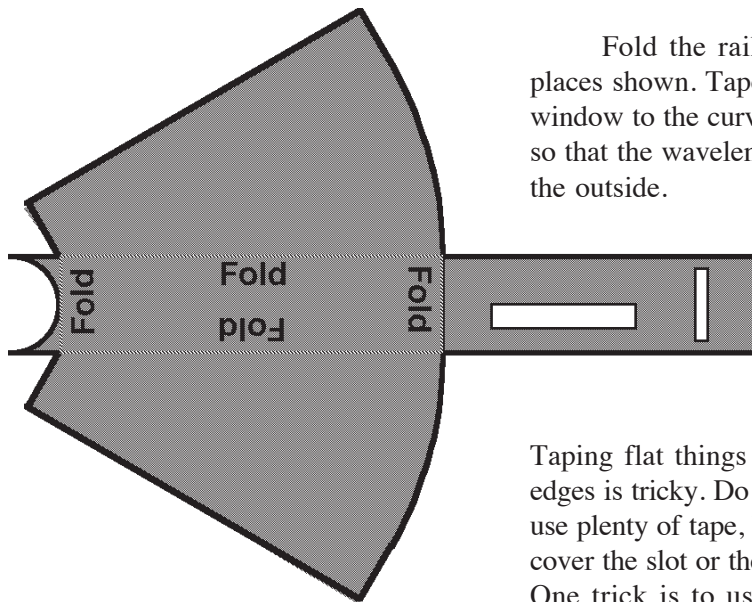
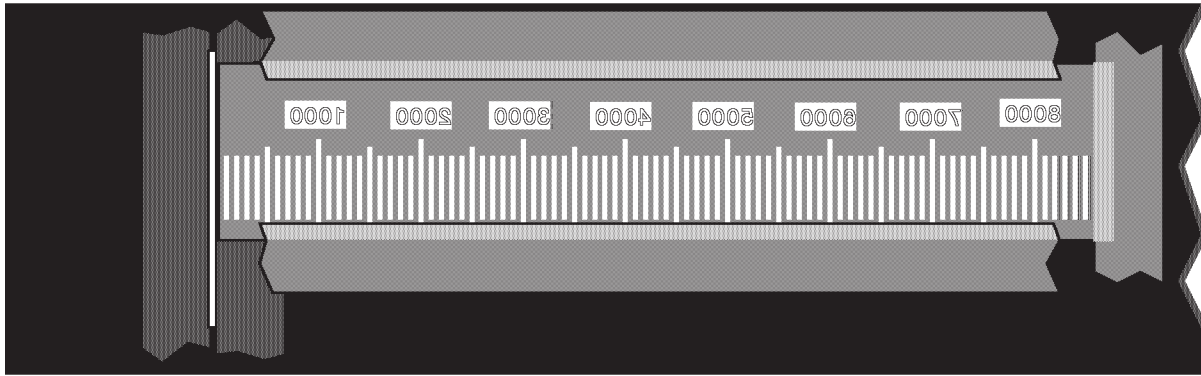

Fold the railroad board body in the four places shown. Tape the flap with the slit and the window to the curved edges of the railroad board so that the wavelength scale is still face down on the outside.

Taping flat things to curved edges is tricky. Do your best, use plenty of tape, but do not cover the slit or the window. One trick is to use a lot of little pieces of tape.

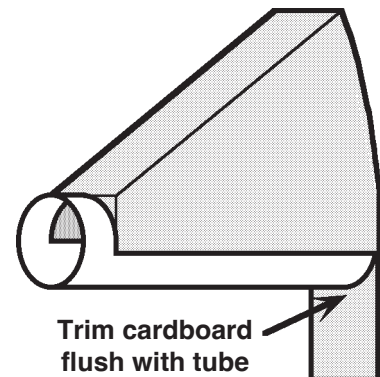
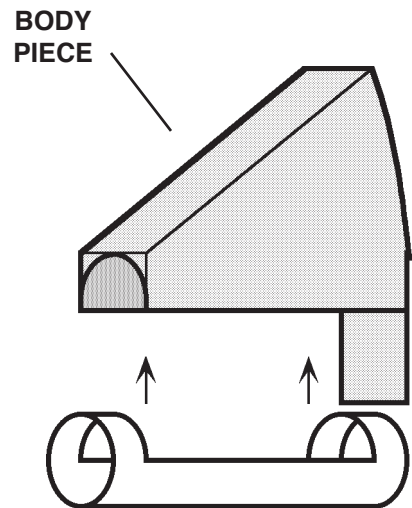

The 9" tube is the backbone of the spectrometer. Attach the railroad board to the 9" tube, as shown, making sure that the section of the tube that is cut out is inside the spectrometer. Trim away the overhanging part of the flap that has the slit and the window. Use enough tape to hold it all together and to seal up all the cracks, but never cover the slit or the window. Slide the eyepiece over the piece of tube that sticks out of the body and your spectrometer is complete.

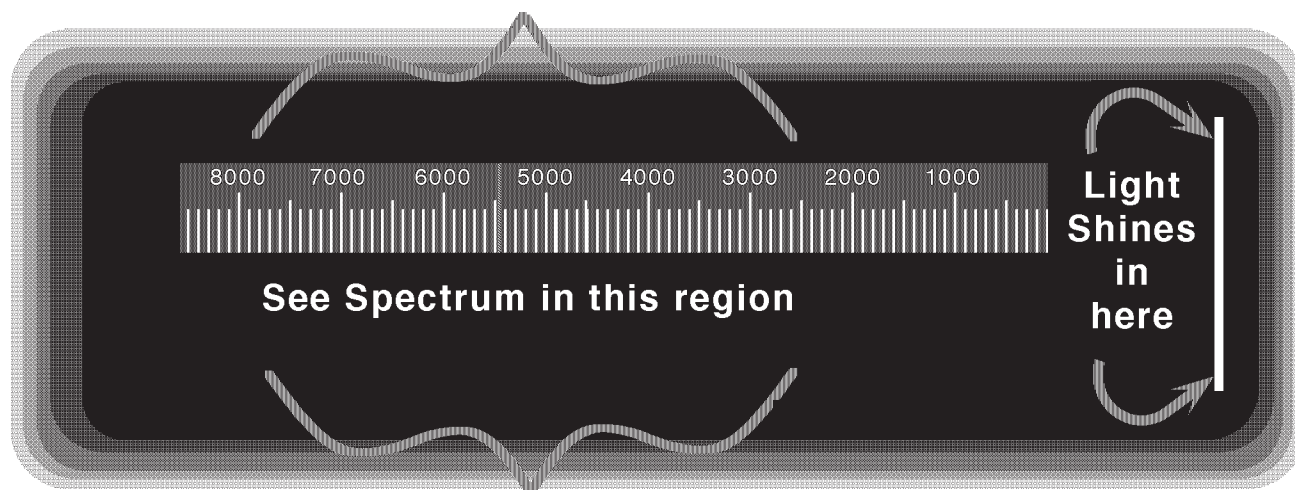

Using your spectrometer

Look through the spectrometer toward a fluorescent light. You should see the light through the slit and somewhere around it a spectrum. At first it may be difficult to see a spectrum. Sometimes the spectrum shows up clearly only when the spectrometer is pointed slightly to one side of the light source. (Actually there are two spectra, one on either side of the light source.) Twist the eyepiece and the spectra will revolve around the slit. Position the eyepiece so that the spectra are on either side of the slit. One of them should lie on top of the wavelength scale.

The spectrum of a fluorescent light looks like a rainbow with a few brightly colored lines. The wavelength of the bright green line is about 5460\AA . The final adjustment before taking any measurements is to pull the eyepiece in or out so that the bright green line appears on the dotted line on the wavelength scale. Tape the eyepiece into place. Now every color will appear on the scale in a position corresponding to its wavelength. If the eyepiece is moved for some reason, find a fluorescent light to readjust it correctly.

There are a few experiments that you can try right away. Look at any bright white light (but never the sun!). Most white light contains every wavelength that the human eye can see. **What is the shortest wavelength that you can see? What is the longest wavelength that you can see?** Different people may be sensitive to slightly different ranges of

wavelengths, so answers to these questions may vary from person to person.

Using crayons or colored pencils or markers, do your best to draw the spectrum of white light as you see it through your spectrometer. Label some of the colors with their wavelengths. **How many colors can you see in the spectrum of white light?** Isaac Newton divided the spectrum into seven colors; red, orange, yellow, green, blue, indigo, and violet. Actually there are an infinite number of different colors. For instance the part of the spectrum that looks red has many different kinds of red, but we have only the word “red” to describe them all. That is one reason why it is handy to be able to measure a color’s wavelength. The wavelength describes the color exactly.

Use your spectrometer to look at colored lights. Some colored lights are simply white lights that shine through colored substances such as paint or colored glass or plastic. These substances filter out some wavelengths of light. Your spectrometer will tell you which wavelengths get through.

Some colored lights are made with substances that give off light with only a few wavelengths. Neon signs give off light only with certain wavelengths in the red, orange and yellow parts of the spectrum. Neon also gives off a wavelength in the green part of the spectrum, but the combined light always appears orange. Find a neon light and draw its spectrum,

Colors From Space

labeling the colors with the wavelengths that you measure. Some lights that people call ‘neon lights’ contain no neon at all. If you can find some of these lights to observe with your spectrometer, note the wavelengths of the colors that are given off. The wavelengths are unique to each element. This means that the wavelengths that you observe can be used to identify what substances are giving off the light.

Even some lights that look white have certain wavelengths that are particularly bright. Many street lights are good examples of this. So are fluorescent lights. The bright green wavelength that you observe when looking at a fluorescent light is given off by mercury. Look in a physics reference book such as *The Handbook of Chemistry and Physics* for a table that shows the wavelengths for the emission spectra of the elements to find out what elements are giving off the other colors that you see in your spectrometer.

Happy spectrum watching!

[Scales below for photocopying]

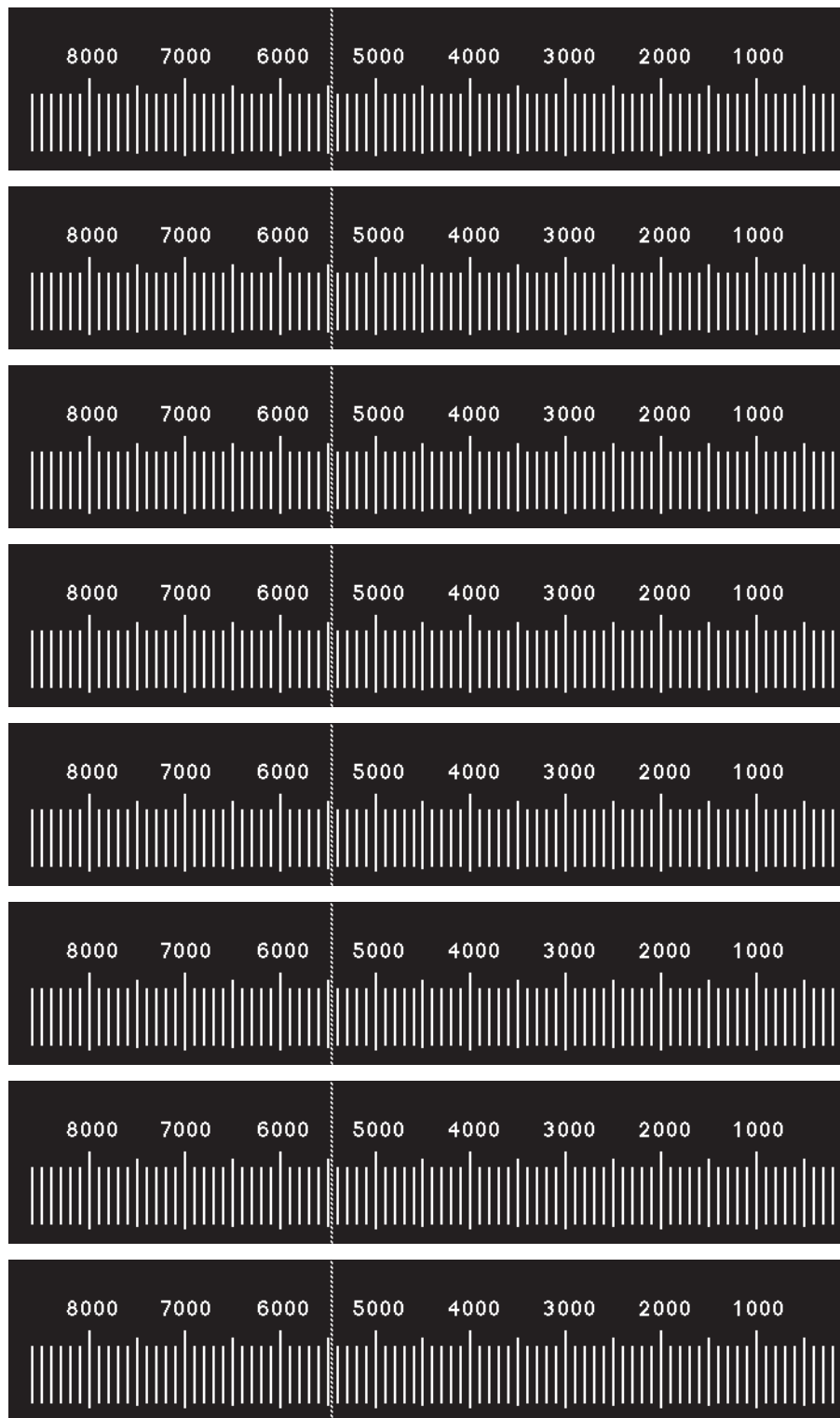

Spectrometer Body Template

Lawrence Hall of Science
University of California
Berkeley, CA 94720-5200

- Copy these two pages on cardstock.
[or paste onto cardstock]
- Overlap corresponding arrows.
- Cut along solid lines.
- Fold along dotted lines.

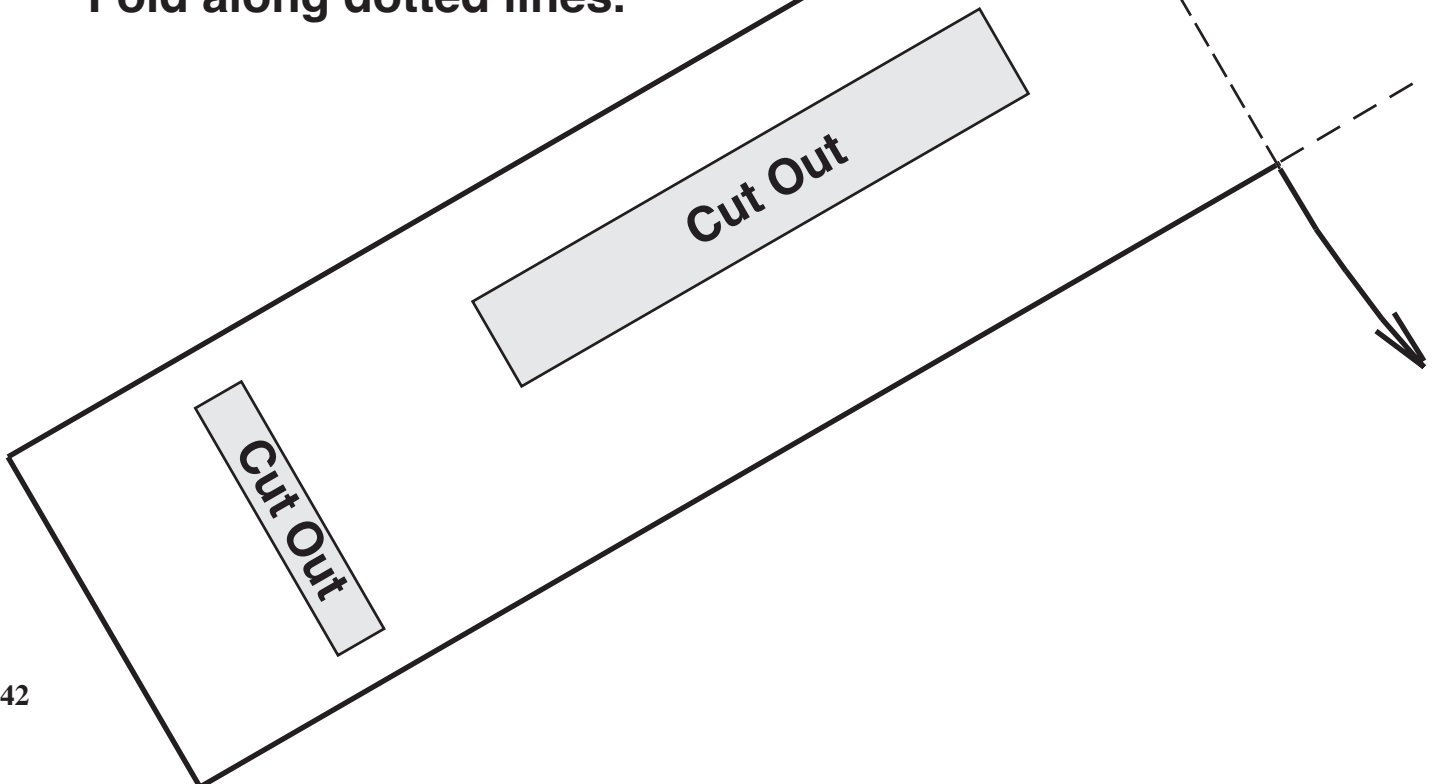

© 1990 by the Regents of the University of California

